

W140 Diagnostic Trouble Codes (DTC) – Models with M119 Engine Only!

The pages in this document have the Diagnostic Trouble Codes (DTC's) for the following models, all of which have M119 V8 engines with LH-SFI (LH Sequential Fuel Injection):

1992-1993 400SE, 400SEL, 400SEC (4.2L M119.971 engine)
1992-1993 500SE, 500SEL, 500SEC (5.0L M119.970 engine)
1994-1995 S420, S500 (4.2L and 5.0L M119.97x engines)

The chassis covered are:

140.042, 140.043 (Sedan with 4.2L M119.971 engine)
140.063 (Coupe with 4.2L M119.971 engine)
140.050, 140.051 (Sedan with 5.0L M119.970 engine)
140.070 (Coupe with 5.0L M119.970 engine)

The diagnostic connector has a total of 38 pins; please see the next several pages which explain the specifics of each pin. Note that not all pins are used. Also, for models with the 4.2L engine, ASR traction control was optional. The DTC's are slightly different on pins 6 and 7, between models with ABS only (no ASR), and models with both ABS and ASR. Please make sure you are using the correct sheets when looking up codes for ABS/ASR, and the EA/CC/ISC systems! To determine if your vehicle has ASR, check the instrument cluster. Models with ASR will have an illuminated yellow warning triangle in the top/center of the speedometer. All USA models with 5.0L engines have ASR as standard equipment.

- Models **without** ASR have a CC/ISC (Cruise Control / Idle Speed Control) module, N4/3, which controls the CC/ISC actuator (M16/2). The ABS control module is N30.
- Models **with** ASR have an EA/CC/ISC (Electronic Accelerator / Cruise Control / Idle Speed Control) module, N4/1, which controls the EA/CC/ISC actuator (M16/1). The ABS/ASR control module is N30/1.

Most systems have analog "blink codes" available, which can be read with the factory impulse counter tool, or a home-made "LED light box". However, the digital 3- or 4-digit codes are often more specific than the analog 1- or 2-digit codes. Certain systems can only have their codes read with a Mercedes digital scanner, such as the HHT (Hand Held Tester) or SDS (Star Diagnosis System); or with an aftermarket digital scan tool (such as the Snap-On MT2500, Modis, or Solus). For example, the SRS / Airbag system (pin #30) as of 07/1993 production (i.e., as of model year 1994) requires a digital scanner to communicate, no blink codes are available for this system.

One other system (ACC, Automatic Climate Control) does not have analog blink codes available at the 38-pin connector. The ACC codes can be accessed with a digital scanner, or with the ACC control panel inside the vehicle. Please see the ACC documentation for details on this procedure.

The Check Engine Light (CEL) may only be present on models with California emissions. Only these models will have a Diagnostic Module (DM). DM codes can be read using the built-in pushbutton & LED mounted at the front corner of the CAN box, near the 38-pin connector. ONLY codes from the DM will show using the built-in LED: you cannot read codes from the LH, ABS, ASR, E-GAS, etc from this LED!! You can also read the DM blink codes with a digital scanner, or by using a separate LED impulse counter code reader at pin #19.

This document includes the complete list of DTC's for the following systems:

Pin #4 – LH-SFI (LH Sequential Fuel Injection)

(WIS Group 07.41, subgroup 3.1, section #11, five pages)

Pin #6 - ABS (Anti-lock Brake System) - For models without ASR

(WIS Group 42.30, subgroup 6.2, section #11, one page)

Pin #6 - ABS / ASR (Anti-lock Brake System / ASR) - For models with ASR traction control

(WIS Group 42.40, subgroup 5.2, section #12, two pages)

Pin #7 - CC/ISC (Cruise Control / Idle Speed Control) - For models without ASR

(WIS Group 30.21, subgroup 6.2, section #11, two pages) – aka “E-GAS Module”

Pin #7 - EA/CC/ISC (Electronic Accelerator / CC / ISC) - For models with ASR traction control

(WIS Group 30.20, subgroup 6.2, section #11, two pages) – aka “E-GAS Module”

Pin #8 - Base Module (*Power supply for the other modules – has 4 fuses on top*) – aka “Basic Module”

(WIS Group 54.21, subgroup 1.1, section #11, one page)

Pin #11 - ADS (Adaptive Damping System)

(WIS Group 32.32, subgroup 3.2, section 12, one page)

Pin #12 - SPS / PML (Speed Sensitive Power Steering)

(WIS Group 46.50, subgroup 7.1, section 11, one page)

Pin #16 - ACC (Automatic Climate Control) - *Blink codes not available at 38-pin connector, see documentation*

(WIS Group 83.40, subgroup 3.2, section 14, four pages)

Pin #17 - EZL (Digital Ignition System)

(WIS Group 07.41, subgroup 5.2, section #11, two pages)

Pin #19 - Diagnostic Module (CA models only – will also have LED + pushbutton in front of CAN box)

(WIS Group 07.41, subgroup 8.2, section #11, one page)

Pin #20 – PSE (Pneumatics System Equipment)

(WIS Group 80.00, subgroup 3.1, section #12, one page)

Pin #21 – Convenience System

(WIS Group 80.45, subgroup 5.1, section #12, two pages)

Pin #23 - ATA (Anti-Theft Alarm)

(WIS Group 80.50, subgroup 13.2, section #12, one page)

Pin #30 - Airbag / SRS (Supplemental Restraint System) – up to 07/1993 (1992-1993 model years)

(WIS Group 91.60, subgroup 16.2, section 12, one page) – *Only blink codes are available*

Pin #30 - Airbag / SRS (Supplemental Restraint System) – as of 07/1993 (1994-1995 model years)

(WIS Group 91.60, subgroup 16.3, section 12, three pages) – *Only digital codes available*

Pin #31 – IRCL (Infrared Remote Central Locking)

(WIS Group 80.30, subgroup 4.2, section #12, one page)

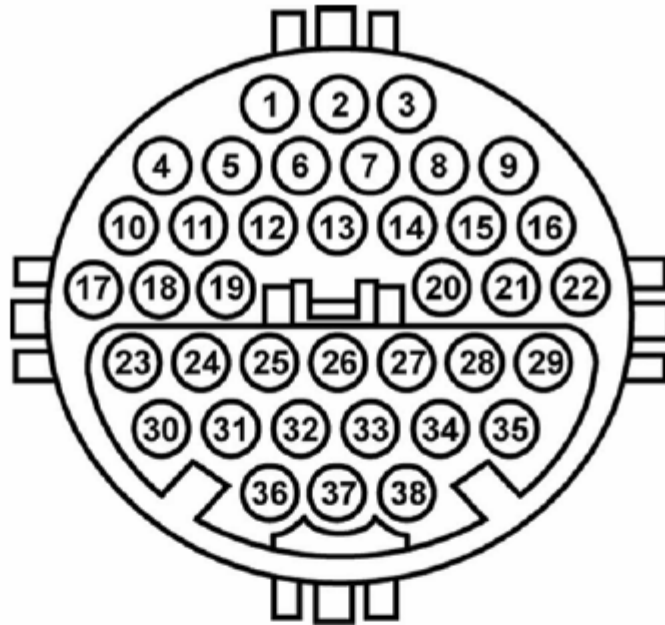

Figure 3-14 38-pin connector—fits MB-1 adapter

Table 3-2 38-pin connector pinout (sheet 1 of 2)

PIN	FUNCTION	PIN	FUNCTION
1	Ground, circuit 31 (W12, W15, electronics ground)	14	On-off ratio, engine 119 LH-SFI, engine 120 LH-SFI (right)
2	Voltage, circuit 87 or 15z	15	On-off ratio, engine 120 LH-SFI (left)
3	Voltage, circuit 30		Instrument cluster
4	Electronic diesel system	16	Air conditioning (models 124, 202, 208, 210)
	Electronic distributor-type fuel injection (diesel)		Tempmatic air conditioning (model 170)
	Electronic inline fuel injection (diesel)	17	Distributor ignition, engines 104, 119, engine 120 (right)
	HFM sequential multiport fuel injection/ignition		TD-speed signal (time division) (diesel) (model 140)
	LH sequential multiport fuel injection, engines 104, 119, 120 (right)		TN-speed signal, LH-SFI engines, HFM (model 202)
ME sequential multiport fuel injection/ignition, engines 119, 120 (right)	18	Distributor ignition, engine 120 (left)	
5	LH sequential multiport fuel injection, engine 120 (left)	19	Diagnostic module
	ME sequential multiport fuel injection/ignition, engine 120 (left)		20
6	Antilock brake system	21	
	Electronic traction system		Convenience feature (model 140)
	Acceleration slip regulation	22	Roadster soft top (model 129)
	Electronic stability program		Roll bar (model 129)
7	Electronic accelerator	23	Anti-theft alarm
	Cruise control/idle speed control	24–25	Not used
8	Base module	26	Automatic locking differential (model 202)
	Brake assist	27	Not used

Table 3-2 38-pin connector pinout (sheet 2 of 2)

PIN	FUNCTION	PIN	FUNCTION
9	Automatic locking differential (models 124, 129, 140)	28	Parktronic system (model 140)
10	Electronic transmission control (A/T 5-speed)	29	Not used
	Electronic transmission control	30	Airbag/ETR (SRS)
11	Adaptive damping system	31	Remote central locking
12	Speed-sensitive power steering	32–33	Not used
13	TNA-signal (gasoline) LH-SFI engines	34	Communication and navigation system
	TD-signal (diesel) (model 210)	35–38	Not used
	TN-signal (gasoline), HFM (ME)-SFI engines		

Diagnosis - Diagnostic Trouble Code (DTC) Memory

Preliminary work: Engine Test and Adjustment, Engines, Volume 1

On-Off Ratio Test

The on-off ratio tests the operation of the O2S (Lambda) control system and additionally, recognizes certain malfunctions present during the test.

Malfunctions are distinguished between those that occur with the **Ignition: ON** and those that occur with the **Engine: at CTP (idle)**.

The on-off ratio can be checked with the on-off ratio tester or with the engine analyzer. For this purpose, the purge line to the engine must be disconnected at the purge control valve and closed with a plug. Check on-off ratio at closed throttle speed and at 2500 rpm. A readout of 50% or an oscillating needle indicates that all input signals and the O2S control system are OK. Readouts of 10% to 90% or 95% refer to a particular malfunction source (see Malfunction Tables). In addition, after testing the on-off ratio, an impulse readout **must be performed** using the impulse counter scan tool.

Diagnostic Trouble Code (DTC) Readout with Impulse Counter Scan Tool.

Malfunctions which occur while starting or with the engine running are recorded by a malfunction counter. Malfunctions are assigned a specific value according to malfunction severity (e.g. hot wire MAF sensor 128, ECT sensor 32). The malfunction counter counts in stages up to a threshold value of 255. After reaching the threshold value of 128, intermittent malfunctions are stored into memory after switching off the ignition. Malfunctions which affect engine operation (≥ 128) are immediately stored into DTC memory by the malfunction counter after switching off the ignition.

Diagnosis - Diagnostic Trouble Code (DTC) Memory

DTC's can be read with the impulse counter scan tool. Numbers ranging from 1 to 32 may appear on the display of the impulse counter scan tool.

The number 1 indicates: No DTC recognized in system.

All further numbers refer to a particular malfunction source. If there are multiple system malfunctions, the malfunction assigned with the lowest number will be displayed first.

If the DTC number indicated first reappears after more than two DTC readouts, then no further malfunctions are stored in the system's memory.

After eliminating all malfunctions, they must be **cleared individually and the ignition must be switched off for a minimum of 15 seconds**.

In case of engine running complaints, the DTC memory must be read and the malfunction must be eliminated before proceeding with any additional repairs.

LH-SFI Control Module Self-Adaptation Feature

A self-adaptation feature for the emission control system is incorporated into the LH-SFI control module.

If malfunctions of the:

- Hot-wire MAF sensor,
- Injectors,
- Purge control valve,
- Diaphragm pressure regulator,
- Purge valve

occur or if intake air leaks are present, the LH-SFI control module conducts a self-adaptation process whereby the correction factors are continuously calculated and permanently stored.

Diagnosis - Diagnostic Trouble Code (DTC) Memory

LH Fuel Injection (Pin #4)

If a malfunction is no longer present during a subsequent engine start or engine operation, the total value recorded by the malfunction counter is reduced by 1 every time the engine is switched off. This procedure repeats itself until the malfunction counter is cleared.

Stored malfunctions (DTC's) can be read with the impulse counter scan tool at the data link connector (X11/4). (Also see DM, Engines, Volume 2, section 5.)



The DTC memory readout must be performed with the engine OFF and the ignition switched ON.

Malfunctions occurring in the following areas are stored immediately:

- CMP sensor,
- Hot-wire MAF sensor,
- Injectors.

A malfunction of the following is stored after more than 2 trips:

- TN-signal (input).

The memory remains active even if the vehicle's battery is disconnected.

After eliminating the mentioned malfunctions or after trial installation of a LH-SFI control module from another vehicle, the LH-SFI control module's self-adaptation feature must be reset to its mean value (see Resetting LH-SFI Control Module's Self-Adaptation Feature to Mean Value" 11/4 or with HHT menu selection 5 Self-Adaptation.

The LH-SFI control module will also adapt itself during the course of vehicle operation.

Notes for HHT

- Fault search with HHT.
Diagnostic trouble code (DTC) memory: Select "Current DTC's".
If the actual condition changes, e.g. when wiggling a connector, the change is reported optically and acoustically so that troubleshooting can be performed directly with the HHT.

- Loose connections.
Loose connections are stored if they occur several times in a certain time period. Therefore, they can appear only as "Stored DTC's" and never as "Current DTC's".

- Nominal values.
All nominal values relative to the actual values as shown on the HHT are listed in the DM, Engines, Volume 1, section A.

- Actual values for ECT, IAT and MAF.
In case of an open or short circuit, the actual value is immediately replaced by a substitute value which is very close to the actual value. Therefore, a fault can not be recognized clearly. A readout of the fault is possible only via the diagnostic trouble code (DTC) memory.

- Actual value for engine rpm.
In case of the engine rpm's, the HHT display shows the closed throttle (idle) speed nominal value calculated by the control module on the left, and on the right, the rpm actual value. Both values should differ from each other only slightly. The permissible tolerances are not known.

Diagnosis - Diagnostic Trouble Code (DTC) Memory

Preparation for Test with Impulse Counter Scan Tool

- Connect impulse counter scan tool and on-off ratio tester according to connection diagram.
- **Reading Diagnostic Trouble Code (DTC) Memory**
 - a) Ignition: **ON**
 - b) Press start button for 2 to 4 seconds.
 - c) Read and record DTC readout.
 - d) Press start button again for 2 to 4 seconds.
 - e) Read and record DTC readout.

Repeat steps d) and e) until the first DTC reappears.

Clearing Diagnostic Trouble Code (DTC) Memory

- a) Press start button for 2 to 4 seconds (DTC readout appears).
 - b) Wait 3 seconds, press start button for 6 to 8 seconds, thereby clearing the previously displayed DTC from memory.
 - c) Each stored DTC must be cleared individually.
 - d) Ignition: **OFF** and wait 15 seconds.
- Check if all stored DTC's are eliminated.**
- e) Ignition: **ON**
 - f) Repeat DTC readout. The number "!" (no DTC stored) must appear.

Resetting LH-SFI Control Module's Self-Adaptation Feature to Mean Value

After the number "!" appears on the display, press start button for 6 to 8 seconds.
Ignition: **OFF** and wait 30 seconds.

Diagnosis - Diagnostic Trouble Code (DTC) Memory

Special Tools

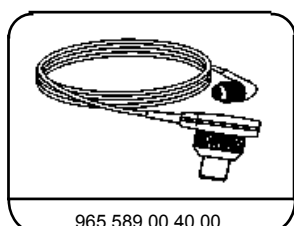
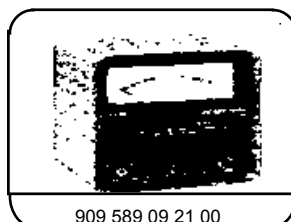
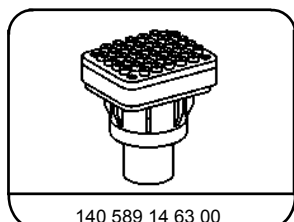
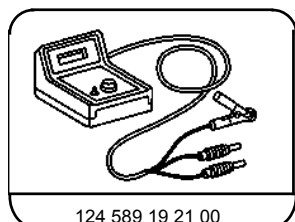

Diagnosis - Diagnostic Trouble Code (DTC) Memory

Connection Diagram - Impulse Counter Scan Tool and On-Off Ratio Tester or Engine Analyzer with Diagnostic Socket X11

Note:

Connect red wire of impulse counter scan tool to socket 3, black wire of impulse counter scan tool to socket 1, yellow wire of impulse counter scan tool as follows:

- | | |
|--------------------------|-----------|
| LH-SFI control module | Socket 4 |
| DI control module | Socket 17 |
| Base module | Socket 8 |
| EA/CC/ISC control module | Socket 7 |
| Diagnostic module | Socket 19 |

**LH Fuel Injection
(Pin #4)**

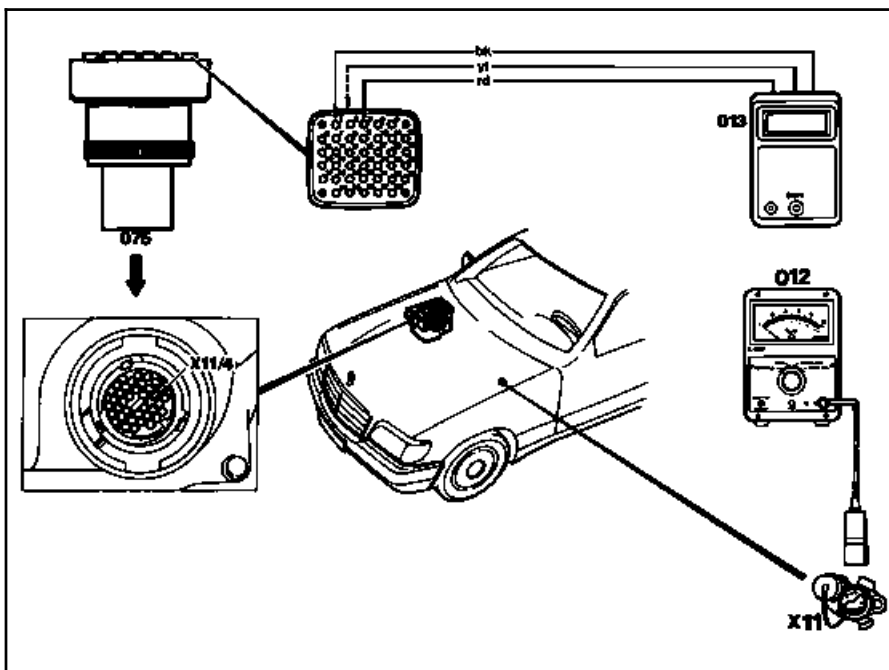

Figure 1

- | | |
|-------|-----------------------------------|
| 012 | On-off ratio tester |
| 013 | Impulse counter scan tool |
| 075 | Impulse counter scan tool adaptor |
| X11 | Diagnostic socket (9-pole) |
| X11/4 | Data link connector (DTC readout) |

U07-5004-57

Diagnosis - Diagnostic Trouble Code (DTC) Memory

Connection Diagram - Impulse Counter Scan Tool/ Hand-Held Tester and On-Off Ratio Tester without Diagnostic Socket X11

Note:

Connect red wire of impulse counter scan tool to socket 3, black wire of impulse counter scan tool to socket 1, yellow wire of impulse counter scan tool as follows:

- | | |
|--------------------------|-----------|
| LH-SFI control module | Socket 4 |
| Base module | Socket 8 |
| EA/CC/ISC control module | Socket 7 |
| Diagnostic module | Socket 19 |
| RPM signal (TN output) | Socket 13 |
| On-off ratio readout | Socket 14 |
| Circuit 31 | Socket 1 |
| Circuit 30 | Socket 3 |

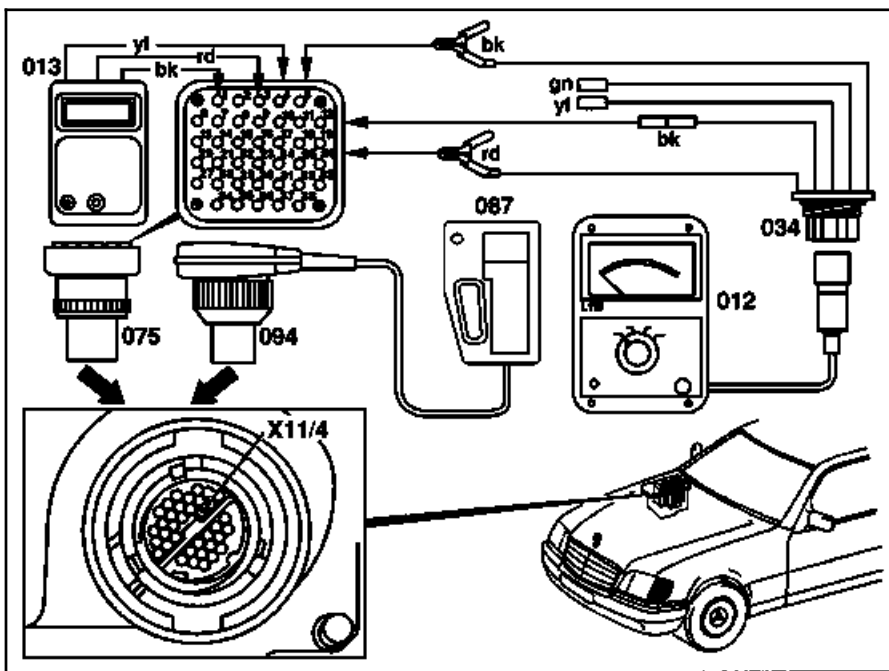

Figure 2

- | | |
|-------|--|
| 012 | On-off ratio tester |
| 013 | Impulse counter scan tool |
| 034 | Test cable |
| | Red alligator clip to socket 3 |
| | Black alligator clip to socket 1 |
| | Black male plug to socket 14 |
| | Green male plug not connected |
| | Yellow male plug not connected |
| 075 | Impulse counter scan tool adaptor |
| 087 | Hand-Held Tester (optional with impulse counter scan tool) |
| 094 | Multiplex cable |
| X11/4 | Data link connector (DTC readout) |

U07-6491-57

Diagnosis - Diagnostic Trouble Code (DTC) Memory

a) On-Off Ratio Test, Ignition: ON

On-Off Ratio %	Possible cause	Test step/Remedy ¹⁾
00	Voltage supply from socket 3 of data link connector (X11/4) open circuit	Repair harness
10	CTP (idle) recognition inactive	□ 23 ⇒ 15.0
20	WOT (full load) recognition active	□ 23 ⇒ 15.0
30	Engine coolant temperature < 70 °C or >110 °C	□ 23 ⇒ 9.0, 10.0
40	Not used	
50	Input signals OK	
60	TN-signal (rpm signal) or CMP sensor signal not present while starting	□ 23 ⇒ 12.0 - 14.0
70	Starter engaged	□ 23 ⇒ 8.1
80	CAN-data exchange defective	□ 23 ⇒ 39.0

90	Fuel safety shut-off active	Check CC/ISC (see DM, Engines, Volume 3, Section 7.1) or Check EA (see DM, Engines, Volume 3, Section 6.2)
----	-----------------------------	--

1) Observe Preparation for Test, see □ 22.

Diagnosis - Diagnostic Trouble Code (DTC) Memory

**LH Fuel Injection
(Pin #4)**

b) On-Off Ratio Test, Engine: at CTP (idle)

On-Off Ratio %	Possible cause	Test step/Remedy ¹⁾
0	Short circuit to battery + in wire to data link connector (X11/4), socket 3	Repair harness
10	CTP (idle) recognition applied constantly	□ 23 ⇒ 15.0
20	Output of fuel injectors or one or more fuel injectors have open circuit	□ 23 ⇒ 32.0, 33.0
30	ECT sensor (B11/2)	□ 23 ⇒ 9.0, 10.1
40	Hot wire MAF sensor (B2/2)	□ 23 ⇒ 5.0, 6.0
50 ²⁾	O2S 1 (before TWC) (G3/2) not operational or defective, open circuit	□ 23 ⇒ 18.0 - 19.1
60	CMP sensor (L5/1)	□ 23 ⇒ 14.0
70	TN-signal (rpm signal)	□ 23 ⇒ 12.0, 13.0
80	CAN-data exchange defective	□ 23 ⇒ 39.0 - 40.0 Either EA/CC/ISC control module, CC/ISC control module or DI control module not transmitting.

1) Observe Preparation for Test, see □ 22.

2) Needle oscillates if all monitored signals are OK.

Diagnosis - Diagnostic Trouble Code (DTC) Memory

b) On-Off Ratio Test, Engine: at CTP (idle)

On-off Ratio %	Possible cause	Test step/Remedy ¹⁾
90	Vehicle speed signal (VSS)	Check CC/ISC (see DM, Engines, Volume 3, section 7.1) or Check EA (see DM, Engines, Volume 3, section 6.2)
95	Deceleration shut-off active	Check CC/ISC (see DM, Engines, Volume 3, section 7.1) or Check EA (see DM, Engines, Volume 3, section 6.2)
100	No voltage at LH-SFI control module (N3/1)	□ 23 ⇒ 1.0 - 3.0

1) Observe Preparation for Test, see □ 22.

Diagnosis - Diagnostic Trouble Code (DTC) Memory

c) LH-SFI Control Module DTC Readout

DTC	Possible cause	Test step/Remedy ¹⁾
P0	No malfunction in system	-
P1	ECT sensor (B11/2) sensor circuit 1, open/short circuit	□ 23 ⇒ 9.0
P2	ECT sensor (B11/2) sensor circuit 2, open/short circuit	□ 23 ⇒ 10.0
P4 ²⁾	Voltage at hot wire MAF sensor (B2/2) insufficient or too high, or open circuit in ground wire at hot wire MAF sensor	□ 23 ⇒ 5.0 - 6.0
P5	Not used	-
P6	Not used	-
P7	TN-signal (rpm signal) incorrect or open/short circuit	□ 23 ⇒ 12.0
P8	CMP sensor (L5/1) signal, open/short circuit	□ 23 ⇒ 14.0
P9	Starter signal (circuit 50) missing, open/short circuit	□ 23 ⇒ 8.1
P10 ³⁾	CTP (idle) recognition from EA/CC/ISC control module (N4/1) or CC/ISC control module (N4/3), short circuit	□ 23 ⇒ 15.0
P11 ⁴⁾	Secondary air injection system, open/short circuit	□ 23 ⇒ 23.0

1) Observe Preparation for Test, see □ 22.

2) DTC P4 can be displayed on vehicles up to 7/91 even if no fault is present.

3) DTC P10 can be displayed on vehicles up to 7/91 even if no fault is present.

4) DTC P11 can be displayed on vehicles up to 7/91 even if no fault is present.

Diagnosis - Diagnostic Trouble Code (DTC) Memory

c) LH-SFI Control Module DTC Readout

DTC	Possible cause	Test step/Remedy ¹⁾
P0	No malfunction in system	-

12	Burn-off control for hot wire MAF sensor, open/short circuit	□ 23 ⇒ 7.0
13	IAT sensor (B17/7), open/short circuit	□ 23 ⇒ 11.0
14	Not used	-
15	Not used	-
16 ⁵⁾	EGR switchover valve (Y27), open/short circuit	□ 23 ⇒ 20.0
17 ⁷⁾	No CAN data transmission with EA/CC/ISC control module (N4/1) or CC/ISC control module (N4/3)	□ 23 ⇒ 39.0 or N4/1 or N4/3.
18 ⁶⁾	No CAN data transmission with DI control module (N1/3)	□ 23 ⇒ 39.0 or N1/3.
19	Not used	-
20	No CAN data transmission from LH-SFI control module (N3/1)	□ 23 ⇒ 40.0
21	O2S 1 (before TWC) (G3/2), open/short circuit	□ 23 ⇒ 18.0

1) Observe Preparation for Test, see □ 22.

5) DTC 16 can be displayed on vehicles up to 7/91 even if no fault is present.

6) DTC 18 can be displayed on vehicles up to 7/91 even if no fault is present.

7) DTC 17 can be displayed even if no fault is present.

**LH Fuel Injection
(Pin #4)**

Diagnosis - Diagnostic Trouble Code (DTC) Memory

c) LH-SFI Control Module DTC Readout

DTC 	Possible cause	Test step/Remedy ¹⁾
22	O2S 1 heater, open/short circuit	□ 23 ⇒ 19.0
23	Purge control valve (Y58/1), open/short circuit	□ 23 ⇒ 24.0
24 (Engine 119 only)	Left adjustable camshaft timing solenoid (Y49/1), open/short circuit	□ 23 ⇒ 27.0
25	Adjustable camshaft timing solenoid, engine 104 (Y49) or right adjustable timing solenoid, engine 119 (Y49/2), open/short circuit	□ 23 ⇒ 26.0
26	Upshift delay switchover valve (Y3/3), open/short circuit	□ 23 ⇒ 34.0
27	Injectors (Y62), open/short circuit	□ 23 ⇒ 32.0
28	LH-SFI control module coding, open circuit	□ 23 ⇒ 43.0
29 (Model 124.034 only)	1GR start relay module (K29/1), open/short circuit	□ 23 ⇒ 44.0

1) Observe Preparation for Test, see □ 22.

Diagnosis - Diagnostic Trouble Code (DTC) Memory

Test Preparation for DTC Readout

1. Connect impulse counter scan tool or Hand-Held Tester to data link connector (X11/4) as shown in section 0.

Note:

Connect yellow wire from impulse counter scan tool as follows:
 ABS control module (N30) socket 6
 Base module (N16/1) socket 8

2. Ignition: **ON**.

3. Read DTC memory of ABS control module (N30), and base module (N16/1).

ABS Only
For models without ASR
 (Pin #6)

Special Tools

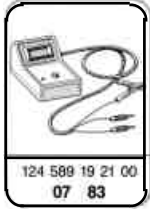

Equipment

Hand-Held Tester (HHT)

see applicable Service Information in groups 58 and 99

Diagnosis - Diagnostic Trouble Code (DTC) Memory

Diagnostic trouble code (DTC)	Possible cause	Test step/Remedy ¹⁾
1	No faults recognized. In case of complaint:	<input type="checkbox"/> 23 (entire test)
2 002	Left front axle vehicle speed sensor (L6/1), open circuit	<input type="checkbox"/> 23 ⇒ 10.0
3 003	Right front axle vehicle speed sensor (L6/2), open circuit	<input type="checkbox"/> 23 ⇒ 12.0
4 004	Rear axle vehicle speed sensor (L6), open circuit	<input type="checkbox"/> 23 ⇒ 14.0
5 006	Left front axle solenoid valve (A7y1)	<input type="checkbox"/> 23 ⇒ 16.0
7 007	Right front axle solenoid valve (A7y2)	<input type="checkbox"/> 23 ⇒ 17.0
8 008	Rear axle solenoid valve (A7y3)	<input type="checkbox"/> 23 ⇒ 18.0
10 010	Return pump (A7m1) or return pump relay (A7k2)	<input type="checkbox"/> 23 ⇒ 6.0
11 011	Solenoid valve relay (A7k1)	<input type="checkbox"/> 23 ⇒ 5.0
12 012	Models 140.04/05: Master cylinder switchover valve (Y61)	<input type="checkbox"/> 23 ⇒ 7.0
13 013	Brake lamp switch (S9/1)	<input type="checkbox"/> 23 ⇒ 9.0
14 014	Models 140.04/05: Lateral acceleration sensor (B24/2)	<input type="checkbox"/> 23 ⇒ 8.0
15 015	ABS control module (N30)	N30

¹⁾ Observe Preparation for Test, see 22.

Diagnosis - Diagnostic Trouble Code (DTC) Memory

Diagnostic trouble code (DTC)	Possible cause	Test step/Remedy ¹⁾
16 016	Vehicle speed sensors (L6, L6/1, L6/2), implausible signal ²⁾	<input type="checkbox"/> 23 ⇒ 10.0 <input type="checkbox"/> 23 ⇒ 12.0 <input type="checkbox"/> 23 ⇒ 14.0 Visual inspection
17 017	Solenoid valve relay (A7k1)	<input type="checkbox"/> 23 ⇒ 5.0
25 025	Left front axle vehicle speed sensor (L6/1), implausible signal ²⁾	<input type="checkbox"/> 23 ⇒ 10.0
26 026	Right front axle vehicle speed sensor (L6/2), implausible signal ²⁾	<input type="checkbox"/> 23 ⇒ 12.0
27 027	Rear axle vehicle speed sensor (L6), implausible signal ²⁾	<input type="checkbox"/> 23 ⇒ 14.0
29 029	Models 140.04/05: Lateral acceleration sensor (B24/2), implausible signal	<input type="checkbox"/> 23 ⇒ 8.0

¹⁾ Observe Preparation for Test, see 22.

²⁾ Incorrect number of rotor teeth, dirty or damaged, incorrect rear axle ratio, tires or wheels.

Diagnosis - Diagnostic Trouble Code (DTC) Memory

ABS + ASR
For models with ASR
(Pin #6)

Preparation for DTC Readout

1. Connect impulse counter scan tool or Hand-Held Tester (HHT) to data link connector (X11/4) according to connection diagram (see section 0).

Note:

Connect yellow wire from impulse counter scan tool to:

ABS/ASR control module (N30/1)	socket 6
BM (N16/1)	socket 8
SPS control module (N49/1)	socket 12
ADS control module (N51)	socket 11
TCM (N15/1)	socket 10
EA/CC/ISC control module (N4/1)	socket 7

Engine (N3/4), LH-SFI (N3/1) or Right LH-SFI control module (N3/3)	socket 4
Left LH-SFI control module (N3/2)	socket 5
DI (N1/3) or Right DI control module (N1/5)	socket 17
Left DI control module (N1/4)	socket 18

2. Ignition: **ON**
3. Read out DTC's for control modules listed.

Special Tools



Equipment

Hand-Held Tester (HHT)

See S.I. in groups 58 and 99.

Diagnosis - Diagnostic Trouble Code (DTC) Memory

Diagnostic trouble code (DTC)	Possible cause	Test step/Remedy ¹⁾
1 —	No fault in system.	In case of complaint: <input type="checkbox"/> 23 and <input type="checkbox"/> 33 (entire test)
2 002	Left front axle VSS sensor (L6/1), open circuit	<input type="checkbox"/> 23 ⇒ 14.0
3 003	Right front axle VSS sensor (L6/2), open circuit	<input type="checkbox"/> 23 ⇒ 16.0
4 004	Left rear axle VSS sensor (L6/3), open circuit	<input type="checkbox"/> 23 ⇒ 18.0
5 005	Right rear axle VSS sensor (L6/4), open circuit	<input type="checkbox"/> 23 ⇒ 20.0
6 006	ABS/ASR hydraulic unit, left front axle solenoid valve (A7/3y1)	<input type="checkbox"/> 23 ⇒ 23.0
7 007	ABS/ASR hydraulic unit, right front axle solenoid valve (A7/3y2)	<input type="checkbox"/> 23 ⇒ 24.0
8 008	ABS/ASR hydraulic unit, left rear axle solenoid valve (A7/3y3)	<input type="checkbox"/> 23 ⇒ 25.0
9 009	ABS/ASR hydraulic unit, right rear axle solenoid valve (A7/3y4)	<input type="checkbox"/> 23 ⇒ 26.0
10 010	ABS/ASR hydraulic unit, high-pressure/return pump relay (A7/3k2), ABS/ASR hydraulic unit, high-pressure/return pump (A7/3m1)	<input type="checkbox"/> 23 ⇒ 8.0 <input type="checkbox"/> 23 ⇒ 2.0
11 011	ABS/ASR hydraulic unit, solenoid valve relay (A7/3k1)	<input type="checkbox"/> 23 ⇒ 7.0
Models 124.036 (02/92 →), 129.076, 140.04/05/07		
12 012	Master brake cylinder switchover valve (Y61)	<input type="checkbox"/> 23 ⇒ 9.0
13 013	Stop lamp switch (S9/1)	<input type="checkbox"/> 23 ⇒ 10.0

¹⁾ Observe Preparation for Test, see 22.

Diagnosis - Diagnostic Trouble Code (DTC) Memory

Diagnostic trouble code (DTC)	Possible cause	Test step/Remedy ¹⁾
Model 124.036 (02/93 →), 129.076, 140.04/04/07		
14 014	ABS lateral acceleration sensor (B24/2), open circuit	<input type="checkbox"/> 23 ⇒ 13.0
15 015	ABS/ASR control module (N30/1)	Replace N30/1
16 016	Vehicle speed signal (VSS) (L6/1, L6/2, L6/3, L6/4), implausible ^{2) 3)}	<input type="checkbox"/> 23 ⇒ 14.0 <input type="checkbox"/> 23 ⇒ 16.0 <input type="checkbox"/> 23 ⇒ 18.0 <input type="checkbox"/> 23 ⇒ 20.0 Visually inspect
17 017	Battery voltage too low	<input type="checkbox"/> 23 ⇒ 1.0
20 020	ABS/ASR hydraulic unit, switchover/solenoid valve (A7/3y5)	<input type="checkbox"/> 23 ⇒ 27.0
21 021	ABS/ASR hydraulic unit, pressure switch (A7/3s1), charge	<input type="checkbox"/> 23 ⇒ 1.0, 2.0 <input type="checkbox"/> 23 ⇒ 22.0
22 022	ABS/ASR hydraulic unit, pressure switch (A7/3s1), leakage	<input type="checkbox"/> 23 ⇒ 1.0, 2.0 <input type="checkbox"/> 23 ⇒ 22.0
23 023	ABS/ASR hydraulic unit, pressure switch (A7/3s1), hydraulic	<input type="checkbox"/> 23 ⇒ 1.0, 2.0 <input type="checkbox"/> 23 ⇒ 22.0

¹⁾ Observe Preparation for Test, see 22.

²⁾ Rotor with incorrect tooth count, dirt accumulation on or damaged rotor, incorrect rear axle ratio, wrong wheel or tire size.

³⁾ If DTC appears only after repair work, it was caused by applying the brakes or driving vehicle on a dynamometer, erase DTC.

Diagnosis - Diagnostic Trouble Code (DTC) Memory

Diagnostic trouble code (DTC)	Possible cause	Test step/Remedy ¹⁾
24 024	ASR charging pump (M15)	Wiring, <input type="checkbox"/> 33⇒ 1.0, 2.0
25 025	Left front axle VSS sensor (L6/1), implausible ²⁾	<input type="checkbox"/> 23⇒ 14.0 Visually inspect.
26 026	Right front axle VSS sensor (L6/2), implausible ²⁾	<input type="checkbox"/> 23⇒ 16.0 Visually inspect.
27 027	Left rear axle VSS sensor (L6/3), implausible ²⁾	<input type="checkbox"/> 23⇒ 18.0 Visually inspect.
28 028	Right rear axle VSS sensor (L6/4), implausible ²⁾	<input type="checkbox"/> 23⇒ 20.0 Visually inspect.
Model 124.036 (02/93 →), 129.076, 140.04/04/07		
29 029	ABS lateral acceleration sensor (B24/2), implausible	<input type="checkbox"/> 23⇒ 13.0
30 030	CAN data bus to EA/CC/ISC control module (N4/1), interrupted	<input type="checkbox"/> 23⇒ 28.0 Read out DTC for N4/1: see DM, Engines, Vol. 2, sections 6.2 or 6.3 <input type="checkbox"/> 11

¹⁾ Observe Preparation for Test, see 22.

²⁾ Rotor with incorrect tooth count, dirt accumulation on or damaged rotor, incorrect rear axle ratio, wrong wheel or tire size.

ABS + ASR
For models with ASR
(Pin #6)

Diagnosis - Diagnostic Trouble Code (DTC) Memory

Diagnostic trouble code (DTC)	Possible cause	Test step/Remedy ¹⁾
31 031	CAN data bus to LH-SFI control module (N3/1), Left LH-SFI control module (N3/2), Right LH-SFI control module (N3/3), or Engine control module (N 3/4), interrupted	<input type="checkbox"/> 23⇒ 28.0 Read out DTC for N3/1, N3/2, N3/3, N3/4: see DM, Engines, Vol. 2, sections 1.1, 3.1 or 3.2 <input type="checkbox"/> 11
32 032	CAN data bus to DI control module (N1/3), Left DI control module (N1/4), Right DI control module (N1/5), interrupted	<input type="checkbox"/> 23⇒ 28.0 Read out DTC for N1/3, N1/4, N1/5: see DM, Engines, Vol. 2 sections 5.2 or 5.3 <input type="checkbox"/> 11
33 033	CAN data bus, interrupted	<input type="checkbox"/> 23⇒ 28.0 Read out DTC for N4/1: see DM, Engines, Vol. 2, sections 6.2 or 6.3 <input type="checkbox"/> 11 Read out DTC for N1/3, N1/4, N1/5: see DM, Engines, Vol. 2 sections 5.2 or 5.3 <input type="checkbox"/> 11 Read out DTC for N3/1, N3/2, N3/3, N3/4: see DM, Engines, Vol. 2, sections 1.1, 3.1 or 3.2 <input type="checkbox"/> 11 Read out DTC for N15/1: see DM, Chassis & Drivetrain, Vol. 1 section 2.2 <input type="checkbox"/> 12

¹⁾ Observe Preparation for Test, see 22.

Diagnosis - Diagnostic Trouble Code (DTC) Readout

CC / ISC only
For models without ASR
(Pin #7)

Preparation for DTC Readout

- Connect impulse counter scan tool and/or HHT to data link connector (X11/4) according to connection diagram (see section 0).
yellow wire to socket 7

Special Tools

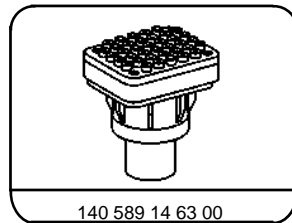
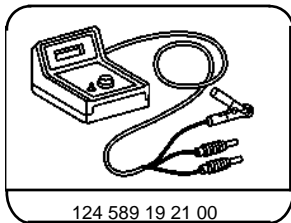

Equipment

Hand-Held Tester (HHT) see current MBNA service information in groups 58 and 99

^{†)} Available through the MBNA Standard Equipment Program.

Diagnosis - Diagnostic Trouble Code (DTC) Readout

Diagnostic trouble code (DTC)	Possible cause	Test step/Remedy ¹⁾
1 -	No fault in system	-
2 002 006	CC/ISC control module (N4/3) Safety contact switch (M16/3s1) Stop lamp switch (S9/1)	N4/3 <input type="checkbox"/> 23 ⇒ 6.0-8.0 <input type="checkbox"/> 23 ⇒ 17.0 <input type="checkbox"/> 23 ⇒ 2.0
007	Cruise control switch (S40) OFF	N4/3 <input type="checkbox"/> 23 ⇒ 3.0, 5.0
008	CC/ISC control module (N4/3) Actual value potentiometer (M16/1r2) Starter lock-out/back-up lamp switch (S16/3) (transmission range recognition)	<input type="checkbox"/> 23 ⇒ 11.0 <input type="checkbox"/> 23 ⇒ 14.0 <input type="checkbox"/> 23 ⇒ 15.0, 16.0
009 025	Engine speed (TNA) signal Vehicle speed signal (VSS) Safety relay within CC/ISC control module (N4/3) CC/ISC control module (N4/3) Engine harness	N4/3 N4/3 Check harness wire insulation.
- 037	Conditions for activation of CC/ISC actuator (M16/2) not fulfilled.	Conditions: Engine: OFF Transmission range: P/N

^{†)} Observe Preparation for Test, see 22.

Diagnosis - Diagnostic Trouble Code (DTC) Readout

Diagnostic trouble code (DTC)	Possible cause	Test step/Remedy ¹⁾
3 054, 056 048 049 050 051 057 055	CC/ISC actuator (M16/2) Throttle valve actual value potentiometer (M16/2r2) Drive actual value potentiometer (M16/2r1) Safety contact switch (M16/2s1) Closed throttle recognition switch (M16/2s2) CC/ISC actuator (M16/2) (voltage supply) Reset not accomplished (actuator adaptation)	<input type="checkbox"/> 23 ⇒ 3.0-10.0 <input type="checkbox"/> 23 ⇒ 5.0 <input type="checkbox"/> 23 ⇒ 4.0 <input type="checkbox"/> 23 ⇒ 6.0, 8.0 <input type="checkbox"/> 23 ⇒ 6.0, 7.0 <input type="checkbox"/> 23 ⇒ 3.0 Erase DTC: Ignition: OFF Ignition: ON (for at least 90 seconds). If DTC reappears: CC/ISC actuator (M16/2)
4 064	Cruise control switch (S40)	<input type="checkbox"/> 23 ⇒ 2.0
5 080	Stop lamp switch (S9/1)	<input type="checkbox"/> 23 ⇒ 17.0
6 097	Not valid for U.S.A. vehicles	

^{†)} Observe Preparation for Test, see 22.

Diagnosis - Diagnostic Trouble Code (DTC) Readout

Diagnostic trouble code (DTC)	Possible cause	Test step/Remedy ¹⁾
7 112 115	CAN databus: Message from CC/ISC control module (N4/3) faulty Reception from LH-SFI control module (N3/1) faulty	N4/3 <input type="checkbox"/> 23 ⇒ 21.0
8 129, 130	Left front axle vehicle speed signal (L6/1) from ABS control module (N30)	<input type="checkbox"/> 23 ⇒ 15.0
9 144	Rear axle vehicle speed signal (L6) from ABS control module (N30)	<input type="checkbox"/> 23 ⇒ 16.0
10 160	Engine speed signal (TNA) from base module (N16/1)	<input type="checkbox"/> 23 ⇒ 14.0
11 176, 182 177-179	Fuel safety shut-off signal to LH-SFI control module (N3/1) Closed throttle recognition signal to LH-SFI control module (N3/1)	<input type="checkbox"/> 23 ⇒ 19.0 <input type="checkbox"/> 23 ⇒ 20.0

CC / ISC only
For models without ASR
(Pin #7)

Diagnosis - Diagnostic Trouble Code (DTC) Readout

EA / CC / ISC
For models with ASR
(Pin #7)

Preparation for DTC Readout

- Connect impulse counter scan tool and/or HHT to data link connector (X11/4) according to connection diagram.
Yellow wire to socket 7

Note

The Test Program is divided into two sections:

- Electronic accelerator with ISC
- Cruise control

According to the diagnosis made, troubleshoot by performing only the related test steps in the particular group.

Special Tools

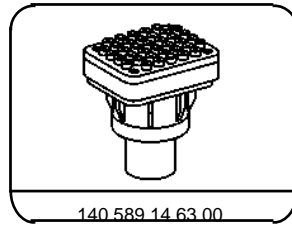
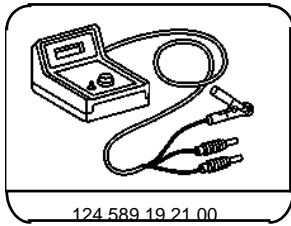

Equipment

Hand-Held Tester (HHT)

see current MBNA service information in groups 58 and 99

Diagnosis - Diagnostic Trouble Code (DTC) Readout

Diagnostic trouble code (DTC)	Possible cause	Test step/Remedy ¹⁾
1 -	No fault in system	-
2 002 006	EA/CC/ISC control module (N4/1) Safety contact switch (M16/1s1) Stop lamp switch (S9/1)	N4/1 <input type="checkbox"/> 23 ⇒ 5.0, 6.0 <input type="checkbox"/> 24 ⇒ 2.0, 3.0
007	Safety contact switch (M16/1s1) Cruise control switch (S40) OFF	<input type="checkbox"/> 23 ⇒ 5.0, 7.0 <input type="checkbox"/> 24 ⇒ 1.0
008	EA/CC/ISC control module (N4/1) Actual value potentiometer (M16/1r2) Starter lock-out/back-up lamp switch (S16/3) (transmission range recognition)	N4/1 <input type="checkbox"/> 23 ⇒ 2.0, 4.0 <input type="checkbox"/> 23 ⇒ 12.0
009 025	Closed throttle position switch (S29/3) Engine speed (TNA) signal Vehicle speed signal (VSS)	<input type="checkbox"/> 23 ⇒ 11.0 <input type="checkbox"/> 23 ⇒ 15.0 <input type="checkbox"/> 23 ⇒ 16.0
- 037	Safety relay within EA/CC/ISC control module (N4/1) EA/CC/ISC control module (N4/1) Engine harness	N4/1 N4/1 Check harness wire insulation.
-	Conditions for activation of EA/CC/ISC actuator (M16/1) not fulfilled.	Conditions: Engine: OFF Transmission range: P/N

¹⁾ Observe Preparation for Test.

Diagnosis - Diagnostic Trouble Code (DTC) Readout

Diagnostic trouble code (DTC)	Possible cause	Test step/Remedy ¹⁾
3 054, 056 048 049, 057 050 051	EA/CC/ISC actuator (M16/1) Reference potentiometer (M16/1r1) Actual value potentiometer (M16/1r2) Safety contact switch (M16/1s1) Closed throttle position switch (M16/1s2)	<input type="checkbox"/> 23 ⇒ 2.0-10.0 <input type="checkbox"/> 23 ⇒ 2.0, 3.0 <input type="checkbox"/> 23 ⇒ 2.0, 4.0 <input type="checkbox"/> 23 ⇒ 5.0, 7.0 <input type="checkbox"/> 23 ⇒ 5.0, 6.0
3 052	Actuator motor (M16/1m1)	<input type="checkbox"/> 23 ⇒ 9.0
3 053	Magnetic clutch (M16/1k1)	<input type="checkbox"/> 23 ⇒ 10.0
- 055	Reset not accomplished (actuator adaptation)	Erase DTCs: Ignition: OFF Ignition: ON (for at least 90 seconds). If DTC appears: EA/CC/ISC actuator (M16/1)
4 064	Cruise control switch (S40)	<input type="checkbox"/> 24 ⇒ 1.0
5 080	Stop lamp switch (S9/1)	<input type="checkbox"/> 24 ⇒ 2.0, 3.0
6 096	Starter lock-out/backup lamp switch (S16/1)	<input type="checkbox"/> 23 ⇒ 12.0
6 097	Not valid for U.S.A. vehicles	
7 112 113 115	CAN databus: Message from EA/CC/ISC control module (N4/1) faulty Message from ABS/ASR control module (N30/1) faulty Message from LH-SFI control module (N3/1) faulty	N4/1, <input type="checkbox"/> 23 ⇒ 20.0 <input type="checkbox"/> 23 ⇒ 20.0

¹⁾ Observe Preparation for Test.

Diagnosis - Diagnostic Trouble Code (DTC) Readout

Diagnostic trouble code (DTC)	Possible cause	Test step/Remedy ¹⁾
8 128-130	Left front axle vehicle speed signal (L6/1) from ABS/ASR control module (N30/1)	□ 23⇒ 16.0
9 144	Left rear axle vehicle speed signal (L6/3) from ABS/ASR control module (N30/1)	□ 23⇒ 17.0
10 160	Engine speed signal (TNA) from base module (N16/1)	□ 23⇒ 15.0
11 176-188	Fuel safety shut-off signal to LH-SFI control module (N3/1)	□ 23⇒ 18.0
- 177-180	Closed throttle recognition signal to LH-SFI control module (N3/1)	□ 23⇒ 19.0
12 192, 193	Voltage supply, circuit 87	□ 23⇒ 1.0
14 224	Closed throttle position switch (S29/3)	□ 23⇒ 11.0
15 240	Data exchange with ABS/ASR control module (N30/1) implausible	N30/1

¹⁾ Observe Preparation for Test.

EA / CC / ISC
For models with ASR
(Pin #7)

Diagnosis - Diagnostic Trouble Code (DTC) Memory

**BM - Base Module
(Pin #8)**

⚠ CAUTION!

On vehicles with ME-SFI (for identification see: control module box), the base module (BM) (N16/1) is not equipped with DTC memory. DTC's can only be retrieved by performing the Electrical Test Program □ 23.

Test Preparation for DTC Readout

1. Connect impulse counter scan tool and adapter or HHT to data link connector (X11/4) as shown in section 0.

Note:

Connect yellow wire from impulse counter scan tool as follows:

Base module (BM) (N16/1)	socket 8
ABS or ASR control module (N30 or N30/1) or ASR/SPS control module (N47-1) or ESP/SPS control module (N47-5)	socket 6
SPS control module (N49/1)	socket 12
ADS control module (N51)	socket 11
EDS control module (N39), LH-SFI or Right LH-SFI control module (N3/1 or N3/3), ME-SFI (Engine 119) or ME-SFI (Engine 120) right engine control module (N3/10, N3/12)	socket 4
Left LH-SFI control module (N3/2) or ME-SFI (Engine 120) left engine control module (N3/11)	socket 5

2. Ignition: **ON**
3. Read DTC memory (as applicable) for appropriately connected: BM, ABS or ASR, ASR/SPS, ESP/SPS, ME-SFI, ADS, LH-SFI control modules.

Special Tools

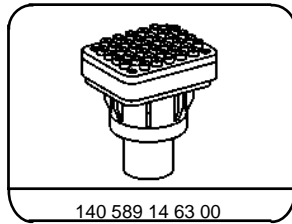
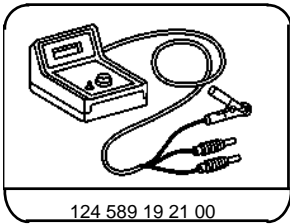

Equipment

Description	
Hand-Held Tester (HHT)	see applicable Service Information in groups 58 and 99

1) Available through the MBNA Standard Equipment Program.

Diagnosis - Diagnostic Trouble Code (DTC) Memory

DTC		Possible cause	Test step/Remedy ¹⁾
001	01	No fault in system.	In case of complaint: □ 23 (entire test)
005	05	Maximum allowable temperature in module box (F23) exceeded ²⁾ .	□ 23 ⇒ 19.0
006	06	A/C electromagnetic clutch (A9k1) jammed or poly-V-belt broken.	□ 23 ⇒ 15.0, visually inspect compressor and poly-V-belt
007	07	Poly-V-belt slips.	□ 23 ⇒ 15.0, check poly-V-belt tension
008	08	Engine 120: Left LH-SFI control module (N3/2) voltage supply, open circuit.	□ 23 ⇒ 4.0
009	09	Engine 104, 119: LH-SFI control module (N3/1) voltage supply, open circuit. Engine 120: Right LH-SFI control module (N3/3) voltage supply, open circuit.	□ 23 ⇒ 3.0
010	010	Base module (N16/1) voltage supply output fuse F2, open circuit.	□ 23 ⇒ 6.0, 8.0
011	011	Base module (N16/1) voltage supply output fuse F3, open circuit.	□ 23 ⇒ 11.0
012	012	Base module (N16/1) voltage supply output fuse F1, open circuit.	□ 23 ⇒ 10.0
013	013	Base module (N16/1) voltage supply output fuse F4, open circuit.	□ 23 ⇒ 5.0, 7.0
015	015	Kickdown switch (transmission mode) (S16/7), short circuit.	□ 23 ⇒ 20.0
016	016	A/C electromagnetic clutch (A9k1), short circuit.	□ 23 ⇒ 15.0
017	017	Module box blower motor (M2/2), short circuit ²⁾ .	□ 23 ⇒ 19.0

1) Observe Preparation for Test, see □ 22.

2) Module box blower motor was phased out of production on model 140 starting M.Y. 1994.

Diagnosis - Diagnostic Trouble Code (DTC) Memory

Test Preparation for DTC Readout

1. Connect impulse counter scan tool or Hand-Held Tester (HHT) to the data link connector (X11/4) according to the connection diagram as shown in section 0.

Note: Connect yellow wire from impulse counter scan tool to:
 ADS control module (N51) socket 11
 Base module (N16/1) socket 8

2. Read out any stored DTC's from ADS control module (N51) and BM (N16/1).

**ADS - Adaptive
 Damping System
 (Pin #11)**

Special Tools

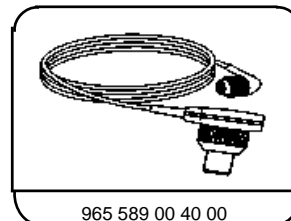
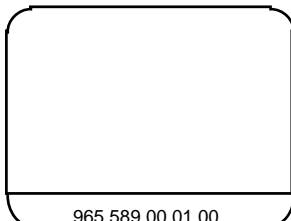
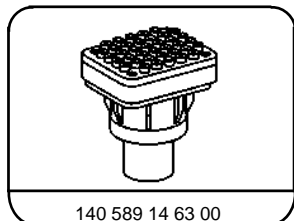
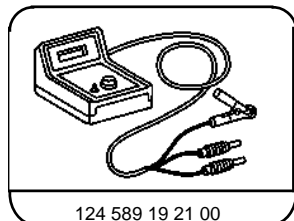

Diagnosis - Diagnostic Trouble Code (DTC) Memory

Diagnostic trouble code (DTC)	Possible cause	Test step/Remedy ¹⁾
1 --	No fault in system.	In case of complaint: <input type="checkbox"/> 23 and <input type="checkbox"/> 33 (entire test)
2 002	ADS control module (N51)	Replace N51.
3 003	Body acceleration sensor (B24)	<input type="checkbox"/> 23 ⇒ 7.0
4 004	Wheel acceleration sensor (B24/1)	<input type="checkbox"/> 23 ⇒ 6.0
5 005	Steering angle sensor (N49)	<input type="checkbox"/> 23 ⇒ 9.0
6 006	Left/right front axle solenoid valve 1 (Y51y1, Y52y1)	<input type="checkbox"/> 23 ⇒ 14.0, 16.0
7 007	Left/right front axle solenoid valve 2 (Y51y2, Y52y2)	<input type="checkbox"/> 23 ⇒ 15.0, 17.0
8 008	Left/right rear axle solenoid valve 1 (Y53y1, Y54y1)	<input type="checkbox"/> 23 ⇒ 12.0
9 009	Left/right rear axle solenoid valve 2 (Y53y2, Y54y2)	<input type="checkbox"/> 23 ⇒ 13.0
10 010	Not for U.S.A. vehicles.	
11 011	Not for U.S.A. vehicles.	
12 012	Model 129 Left front (VSS) from ABS or ABS/ASR control module Model 140 Right front (VSS) from ABS or ABS/ASR control module	<input type="checkbox"/> 23 ⇒ 4.0

¹⁾ Observe Preparation for Test, see 22.

Diagnosis - Diagnostic Trouble Code (DTC) Memory

Diagnostic trouble code (DTC)	Possible cause	Test step/Remedy ¹⁾
Model 129 only		
13 013	Oil level switch (S44)	<input type="checkbox"/> 23 ⇒ 18.0
14 014	Steering angle sensor (N49) not initialized	<input type="checkbox"/> 23 ⇒ 10.0
15 015	Comfort/sport switch (S45/1), short circuit	<input type="checkbox"/> 23 ⇒ 11.0
16 016	Not for U.S.A. vehicles.	
17 017	Vehicle load sensor (N51/1)	<input type="checkbox"/> 23 ⇒ 8.0
18 018	ADS MIL (A1e27)	<input type="checkbox"/> 23 ⇒ 5.0
19 019	Voltage supply too low	<input type="checkbox"/> 23 ⇒ 1.0
20 020	Steering angle sensor (N49)	<input type="checkbox"/> 23 ⇒ 9.0
21 021	Voltage supply too high	<input type="checkbox"/> 23 ⇒ 1.0
22 022	Comfort/sport switch (S45/1)	<input type="checkbox"/> 23 ⇒ 11.0
23 023	Not for U.S.A. vehicles.	

¹⁾ Observe Preparation for Test, see 22.

Diagnosis - Diagnostic Trouble Code (DTC) Memory

Test Preparation for DTC Readout

1. Connect impulse counter scan tool or Hand-Held Tester to data link connector (X11/4) as shown in section 0.

Note:

Connect yellow wire from impulse counter scan tool as follows:

SPS control module (N49/1) socket 12
Base module (N16/1) socket 8

2. Ignition: **ON**.

3. Read DTC memory of SPS control module (N49/1), and base module (N16/1).

**SPS - Speed-sensitive
power steering
(Pin #12)**

Special Tools



Equipment

Hand-Held Tester (HHT)

see applicable Service Information in groups 58 and 99

Diagnosis - Diagnostic Trouble Code (DTC) Memory

Model 140.0 (LH-SFI up 05/93), 140.1 (diesel)

Diagnostic trouble code (DTC)	Possible cause	Test step/Remedy ¹⁾
1 —	No fault recognized. In case of complaint:	<input type="checkbox"/> 23 (entire test)
2 002	Speed-sensitive power steering control module (N49/1)	N49/1
3 003	Rear axle/left rear axle vehicle speed signal malfunction	<input type="checkbox"/> 23 ⇒ 7.0
4 004	Right rear axle vehicle speed signal malfunction	<input type="checkbox"/> 23 ⇒ 6.0
5 005	Comparison of left and right rear axle vehicle speed signals malfunctioning	<input type="checkbox"/> 23 ⇒ 7.0
6 006	Vehicle speed signal from axle missing	<input type="checkbox"/> 23 ⇒ 7.0
7 007	Vehicle speed signal from transmission missing	<input type="checkbox"/> 23 ⇒ 5.0
8 008	Short circuit between speed sensitive power steering P-valve (Y10) (+) and U _{BATT}	<input type="checkbox"/> 23 ⇒ 4.0
9 009	Speed-sensitive power steering P-valve (Y10), short circuit	<input type="checkbox"/> 23 ⇒ 4.0
10 010	Speed-sensitive power steering P-valve (Y10), open circuit	<input type="checkbox"/> 23 ⇒ 4.0
11 011	Voltage supply to speed-sensitive power steering control module (N49/1) insufficient voltage	<input type="checkbox"/> 23 ⇒ 1.0

¹⁾ Observe Preparation for Test, see 22.

Diagnosis - Diagnostic Trouble Code (DTC) Memory

Model 140.0 (HFM-SFI and LH-SFI as of 06/93)

Diagnostic trouble code (DTC)	Possible cause	Test step/Remedy ¹⁾
1 —	No fault recognized. In case of complaint:	<input type="checkbox"/> 23 (entire test)
2 002	Speed-sensitive power steering control module (N49/1)	N49/1
3 003	Comparison of axle vehicle speed signal status/left front axle vehicle speed signal malfunctioning	<input type="checkbox"/> 23 ⇒ 7.0 <input type="checkbox"/> 23 ⇒ 8.0
4 004	Axle vehicle speed signal status missing	<input type="checkbox"/> 23 ⇒ 8.0
5 005	Speed-sensitive power steering control module (N49/1)	N49/1
6 006	Speed sensitive power steering P-valve (Y10); short circuit	<input type="checkbox"/> 23 ⇒ 4.0
7 007	Speed sensitive power steering P-valve (Y10); open circuit	<input type="checkbox"/> 23 ⇒ 4.0
8 008	Short circuit between speed sensitive power steering P-valve (Y10) (+) and U _{BATT}	<input type="checkbox"/> 23 ⇒ 1.0

¹⁾ Observe Preparation for Test, see 22.

Diagnosis - Diagnostic Trouble Code (DTC) Memory

Notes for Diagnosis

- The A/C pushbutton control module (N22) has DTC memory and the capability to display the codes via the temperature display windows (arrows) on the A/C pushbutton control panel. The stored DTC's will remain in memory even with the vehicle battery disconnected.
- The DTC memory can also be read using the Hand-Held Tester (HHT).
- The DTC readout differentiates between continuous as well as intermittent faults.

**ACC - Automatic
Climate Control
(Pin #16)**

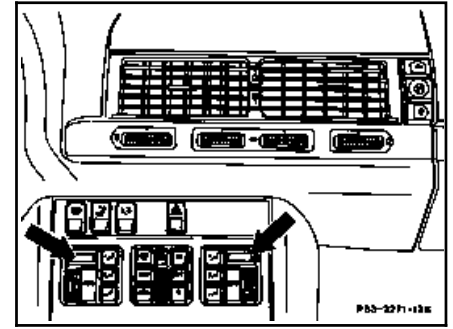

Figure 1

P83-3271-13B

Diagnosis - Diagnostic Trouble Code (DTC) Memory

Preparation for Test

1. Turn left temperature selector wheel to "red" detent.
2. Turn right temperature selector wheel to "blue" detent.
3. Turn ignition **ON**.
4. Press **REST**.
5. Within 20 seconds simultaneously press **EC** and **C** for > 2 seconds.
6. The display will show permanent DTC's stored in memory (see table on following page). Press right **REST** until all stored DTC's are displayed. Record each DTC as it is displayed.
7. Each malfunction (short circuit, open circuit, etc.) has a specific DTC. The letter "E" (Error) along with the hundredth digit of the DTC is displayed in the left window. The tenth and single digit of the DTC is displayed in the right window. By pressing the right **REST** button the next DTC stored in memory will be displayed.

8. Turn ignition **OFF** and repair recorded DTC's according to the respective diagnostic chart.

9. Turn ignition **ON** and press left **REST** button. A "d" (delete) is displayed in the left window.

By pressing the right **REST** button the DTC will be deleted from memory. Continue to press the left and right **REST** buttons until all DTC's are deleted from memory (display will show "E0 00").

10. Return temperature selector wheels to normal setting.

Note:

The red diode in the recirculation switch will blink during the test as of software status 6.2 (Bosch) or 06 (Kammerer).

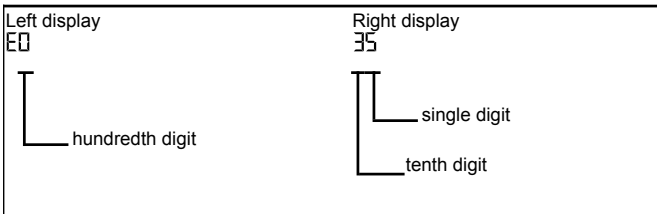

Diagnosis - Diagnostic Trouble Code (DTC) Memory

Diagnostic Trouble Code (DTC)	Possible Cause	Test Step/Remedy ¹⁾
E0 01	No malfunction stored in memory	-
E0 02	A/C pushbutton control module (N22)	A/C pushbutton control module (N22).
E0 03	Rear A/C pushbutton control module (N22/3)	Rear A/C pushbutton control module (N22/3).
E0 06	Connection to switchover valve block (Y11)	Wiring.
E0 07	Data exchange (CAN B), short circuit	Wiring.
E0 08	Data exchange (CAN A), short circuit	Wiring.
E0 09	Data exchange (CAN A and B), short circuit	Wiring.
E0 10	Repeat DTC readout	-
E0 11	Data exchange (CAN B), open circuit	Wiring.
E0 12	Data exchange (CAN A), open circuit	Wiring.
E0 13	Connection to rear A/C pushbutton control module	Wiring.
E0 14	Data exchange (CAN B), open circuit (rear A/C control module)	Wiring.
E0 15	Data exchange (CAN A), open circuit (rear A/C control module)	Wiring.

¹⁾ Observe Preparation for Test, see □ 22.

Diagnosis - Diagnostic Trouble Code (DTC) Memory

Diagnostic Trouble Code (DTC)	Possible Cause	Test Step/Remedy ¹⁾
E0 16	In-car temperature sensor (B10/4), short circuit ²⁾	□ 23 ⇒ 4.0

EO	17	In-car temperature sensor (B10/4), short circuit ³⁾	□ 23 ⇒ 4.0
EO	18	In-car temperature sensor (B10/4), open or short circuit ²⁾	□ 23 ⇒ 4.0
EO	19	In-car temperature sensor (B10/4), open or short circuit ³⁾	□ 23 ⇒ 4.0
EU	24	Left heater core temperature sensor (B10/2), short circuit ²⁾	□ 23 ⇒ 7.0
EU	25	Left heater core temperature sensor (B10/2), short circuit ³⁾	□ 23 ⇒ 7.0
EU	26	Left heater core temperature sensor (B10/2), open or short circuit ²⁾	□ 23 ⇒ 7.0
EO	27	Left heater core temperature sensor (B10/2), open or short circuit ³⁾	□ 23 ⇒ 7.0
EO	28	Right heater core temperature sensor (B10/3), short circuit ²⁾	□ 23 ⇒ 8.0
EU	29	Right heater core temperature sensor (B10/3), short circuit ³⁾	□ 23 ⇒ 8.0
EU	30	Right heater core temperature sensor (B10/3), open or short circuit ²⁾	□ 23 ⇒ 8.0
EU	31	Right heater core temperature sensor (B10/3), open or short circuit ³⁾	□ 23 ⇒ 8.0
EO	32	Outside temperature sensor (B10/5), short circuit ²⁾	□ 23 ⇒ 5.0
EO	33	Outside temperature sensor (B10/5), short circuit ³⁾	□ 23 ⇒ 5.0

- 1) Observe Preparation for Test, see □ 22.
2) Continuous faults.
3) Intermittent faults.

**ACC - Automatic
Climate Control
(Pin #16)**

Diagnosis - Diagnostic Trouble Code (DTC) Memory

Diagnostic Trouble Code (DTC)	Possible Cause	Test Step/Remedy ¹⁾	
EO	34	Outside temperature sensor (B10/5), open or short circuit ²⁾	□ 23 ⇒ 5.0
EO	35	Outside temperature sensor (B10/5), open or short circuit ³⁾	□ 23 ⇒ 5.0
EU	36	Evaporator temperature sensor (B10/6), short circuit ²⁾	□ 23 ⇒ 6.0
EU	37	Evaporator temperature sensor (B10/6), short circuit ³⁾	□ 23 ⇒ 6.0
EU	38	Evaporator temperature sensor (B10/6), open or short circuit ²⁾	□ 23 ⇒ 6.0
EO	39	Evaporator temperature sensor (B10/6), open or short circuit ³⁾	□ 23 ⇒ 6.0
EO	40	ECT sensor (B10/8), short circuit ²⁾	□ 23 ⇒ 9.0
EU	41	ECT sensor (B10/8), short circuit ³⁾	□ 23 ⇒ 9.0
EU	42	ECT sensor (B10/8), open or short circuit ²⁾	□ 23 ⇒ 9.0
EU	43	ECT sensor (B10/8), open or short circuit ³⁾	□ 23 ⇒ 9.0
EO	44	Refrigerant pressure sensor (B12), short circuit ²⁾	□ 23 ⇒ 10.0
EO	45	Refrigerant pressure sensor (B12), short circuit ³⁾	□ 23 ⇒ 10.0
EU	46	Refrigerant pressure sensor (B12), open or short circuit ²⁾	□ 23 ⇒ 10.0
EU	47	Refrigerant pressure sensor (B12), open or short circuit ³⁾	□ 23 ⇒ 10.0

- 1) Observe Preparation for Test, see □ 22.
2) Continuous faults.
3) Intermittent faults.

Diagnosis - Diagnostic Trouble Code (DTC) Memory

Diagnostic Trouble Code (DTC)	Possible Cause	Test Step/Remedy ¹⁾	
EO	48	Left temperature selector wheel, short circuit ²⁾	□ 23 ⇒ 12.0
EU	49	Left temperature selector wheel, short circuit ³⁾	□ 23 ⇒ 12.0
EU	50	Left temperature selector wheel, open or short circuit ²⁾	□ 23 ⇒ 12.0
EO	51	Left temperature selector wheel, open or short circuit ³⁾	□ 23 ⇒ 12.0
EO	52	Right temperature selector wheel, short circuit ²⁾	□ 23 ⇒ 11.0
EU	53	Right temperature selector wheel, short circuit ³⁾	□ 23 ⇒ 11.0
EU	54	Right temperature selector wheel, open or short circuit ²⁾	□ 23 ⇒ 11.0
EU	55	Right temperature selector wheel, open or short circuit ³⁾	□ 23 ⇒ 11.0
EO	72	Heater supply unit coolant circulation pump (A31m1), short circuit ²⁾	□ 23 ⇒ 24.0
EO	73	Heater supply unit coolant circulation pump (A31m1), short circuit ³⁾	□ 23 ⇒ 24.0
EU	74	Coolant circulation pump (A31m1), open or short circuit ²⁾	□ 23 ⇒ 24.0
EU	75	Coolant circulation pump (A31m1), open or short circuit ³⁾	□ 23 ⇒ 24.0
EU	76	Coolant circulation pump (A31m1), over load ²⁾	Check mechanical function of circulation pump
EU	77	Coolant circulation pump (A31m1), over load ³⁾	Check mechanical function of circulation pump

- 1) Observe Preparation for Test, see □ 22.
2) Continuous faults.
3) Intermittent faults.

Diagnosis - Diagnostic Trouble Code (DTC) Memory

Diagnostic Trouble Code (DTC)	Possible Cause	Test Step/Remedy ¹⁾	
EU	80	Left duovalve (A31y1), short circuit ²⁾	□ 23 ⇒ 26.0
EU	81	Left duovalve (A31y1), short circuit ³⁾	□ 23 ⇒ 26.0
EU	82	Left duovalve (A31y1), open or short circuit ²⁾	□ 23 ⇒ 26.0
EO	83	Left duovalve (A31y1), open or short circuit ³⁾	□ 23 ⇒ 26.0
EO	84	Right duovalve (A31y2), short circuit ²⁾	□ 23 ⇒ 25.0
EU	85	Right duovalve (A31y2), short circuit ³⁾	□ 23 ⇒ 25.0

EU	86	Right duovalue (A31y2), open or short circuit ²⁾	□ 23 ⇒ 25.0
EU	87	Right duovalue (A31y2), open or short circuit ³⁾	□ 23 ⇒ 25.0
EU	88	A/C compressor ground activation ²⁾	□ 23 ⇒ 10.0, 30.0
EU	89	A/C compressor ground activation ³⁾	□ 23 ⇒ 10.0, 30.0
EU	90	A/C compressor ground activation, open or short circuit ²⁾	□ 23 ⇒ 10.0, 30.0
EU	91	A/C compressor ground activation, open or short circuit ³⁾	□ 23 ⇒ 10.0, 30.0
EU	96	Auxiliary fan, 1st stage activation, short circuit ²⁾	□ 23 ⇒ 19.0
EU	97	Auxiliary fan, 1st stage activation, short circuit ³⁾	□ 23 ⇒ 19.0
EU	98	Auxiliary fan, 1st stage activation, open or short circuit ²⁾	□ 23 ⇒ 19.0
EU	99	Auxiliary fan, 1st stage activation, open or short circuit ³⁾	□ 23 ⇒ 19.0

1) Observe Preparation for Test, see □ 22.

2) Continuous faults.

3) Intermittent faults.

**ACC - Automatic
Climate Control
(Pin #16)**

Diagnosis - Diagnostic Trouble Code (DTC) Memory

Diagnostic Trouble Code (DTC)	Possible Cause	Test Step/Remedy ¹⁾	
E1	00	Auxiliary fan, 2nd stage activation, short circuit ²⁾	□ 23 ⇒ 20.0
E1	01	Auxiliary fan, 2nd stage activation, short circuit ³⁾	□ 23 ⇒ 20.0
E1	02	Auxiliary fan, 2nd stage activation, open or short circuit ²⁾	□ 23 ⇒ 20.0
E1	03	Auxiliary fan, 2nd stage activation, open or short circuit ³⁾	□ 23 ⇒ 20.0
E1	04	Auxiliary fan, 3rd stage activation, short circuit ²⁾	□ 23 ⇒ 21.0
E1	05	Auxiliary fan, 3rd stage activation, short circuit ³⁾	□ 23 ⇒ 21.0
E1	06	Auxiliary fan, 3rd stage activation, open or short circuit ²⁾	□ 23 ⇒ 21.0
E1	07	Auxiliary fan, 3rd stage activation, open or short circuit ³⁾	□ 23 ⇒ 21.0
E1	08	Auxiliary coolant pump control relay module (K30), power supply, short circuit ^{2) 4)}	□ 23 ⇒ 14.0
E1	09	Auxiliary coolant pump control relay module (K30), power supply, short circuit ^{3) 4)}	□ 23 ⇒ 14.0
E1	10	Auxiliary coolant pump control relay module (K30), power supply, open or short circuit ^{2) 4)}	□ 23 ⇒ 14.0
E1	11	Auxiliary coolant pump control relay module (K30), power supply, open or short circuit ^{3) 4)}	□ 23 ⇒ 14.0
E1	12	Engine rpm increase diode matrix (V2), short circuit ²⁾	□ 23 ⇒ 23.0
E1	13	Engine rpm increase diode matrix (V2), short circuit ³⁾	□ 23 ⇒ 23.0
E1	14	Engine rpm increase diode matrix (V2), open or short circuit ²⁾	□ 23 ⇒ 23.0
E1	15	Engine rpm increase diode matrix (V2), open or short circuit ³⁾	□ 23 ⇒ 23.0

1) Observe Preparation for Test, see □ 22.

2) Continuous faults.

3) Intermittent faults.

4) Possible sequential failures 75, 83, 87, 99, I 03.

Diagnosis - Diagnostic Trouble Code (DTC) Memory

Diagnostic Trouble Code (DTC)	Possible Cause	Test Step/Remedy ¹⁾	
E1	16	Activated charcoal filter actuator (A32m2) (OPEN), short circuit ²⁾	□ 23 ⇒ 17.0, 18.0
E1	17	Activated charcoal filter actuator (A32m2) (OPEN), short circuit ³⁾	□ 23 ⇒ 17.0, 18.0
E1	18	Activated charcoal filter actuator (A32m2) (OPEN), open or short circuit ²⁾	□ 23 ⇒ 17.0, 18.0
E1	19	Activated charcoal filter actuator (A32m2) (OPEN), open or short circuit ³⁾	□ 23 ⇒ 17.0, 18.0
E1	20	Activated charcoal filter actuator (A32m2) (CLOSED), short circuit ²⁾	□ 23 ⇒ 17.0, 18.0
E1	21	Activated charcoal filter actuator (A32m2) (CLOSED), short circuit ³⁾	□ 23 ⇒ 17.0, 18.0
E1	22	Activated charcoal filter actuator (A32m2) (CLOSED), open or short circuit ²⁾	□ 23 ⇒ 17.0, 18.0
E1	23	Activated charcoal filter actuator (A32m2) (CLOSED), open or short circuit ³⁾	□ 23 ⇒ 17.0, 18.0

1) Observe Preparation for Test, see □ 22.

2) Continuous faults.

3) Intermittent faults.

Diagnosis - Diagnostic Trouble Code (DTC) Memory (Rear A/C)

Note:

The following DTC's appear only if vehicle is equipped with rear A/C system

Diagnostic Trouble Code (DTC)	Possible Cause	Test Step/Remedy ¹⁾	
E1	28	Left rear heater core temperature sensor (B10/9), short circuit ²⁾	□ 23 ⇒ 34.0
E1	29	Left rear heater core temperature sensor (B10/9), short circuit ³⁾	□ 23 ⇒ 34.0
E1	30	Left rear heater core temperature sensor (B10/9), open or short circuit ²⁾	□ 23 ⇒ 34.0
E1	31	Left rear heater core temperature sensor (B10/9), open or short circuit ³⁾	□ 23 ⇒ 34.0
E1	32	Right rear heater core temperature sensor (B10/10), short circuit ²⁾	□ 23 ⇒ 35.0
E1	33	Right rear heater core temperature sensor (B10/10), short circuit ³⁾	□ 23 ⇒ 35.0
E1	34	Right rear heater core temperature sensor (B10/10), open or short circuit ²⁾	□ 23 ⇒ 35.0
E1	35	Right rear heater core temperature sensor (B10/10), open or short circuit ³⁾	□ 23 ⇒ 35.0
E1	36	Left temperature selector wheel, short circuit ²⁾	□ 23 ⇒ 38.0
E1	37	Left temperature selector wheel, short circuit ³⁾	□ 23 ⇒ 38.0
E1	38	Left temperature selector wheel, open or short circuit ²⁾	□ 23 ⇒ 38.0
E1	39	Left temperature selector wheel, open or short circuit ³⁾	□ 23 ⇒ 38.0

- 1) Observe Preparation for Test, see □ 22.
- 2) Continuous faults.
- 3) Intermittent faults.

Diagnosis - Diagnostic Trouble Code (DTC) Memory (Rear A/C)

Diagnostic Trouble Code (DTC)	Possible Cause	Test Step/Remedy ¹⁾
E1 40	Right temperature selector wheel, short circuit ²⁾	□ 23 ⇒ 37.0
E1 41	Right temperature selector wheel, short circuit ³⁾	□ 23 ⇒ 37.0
E1 42	Right temperature selector wheel, open or short circuit ²⁾	□ 23 ⇒ 37.0
E1 43	Right temperature selector wheel, open or short circuit ³⁾	□ 23 ⇒ 37.0
E1 44	Rear evaporator temperature sensor (B10/11), short circuit ²⁾	□ 23 ⇒ 33.0
E1 45	Rear evaporator temperature sensor (B10/11), short circuit ³⁾	□ 23 ⇒ 33.0
E1 46	Rear evaporator temperature sensor (B10/11), open or short circuit ²⁾	□ 23 ⇒ 33.0
E1 47	Rear evaporator temperature sensor (B10/11), open or short circuit ³⁾	□ 23 ⇒ 33.0
E1 48	Coolant circulation pump (A31/1m1), short circuit ²⁾	□ 23 ⇒ 40.0
E1 49	Coolant circulation pump (A31/1m1), short circuit ³⁾	□ 23 ⇒ 40.0
E1 50	Coolant circulation pump (A31/1m1), open or short circuit ²⁾	□ 23 ⇒ 40.0
E1 51	Coolant circulation pump (A31/1m1), open or short circuit ³⁾	□ 23 ⇒ 40.0
E1 52	Coolant circulation pump (A31/1m1), overload ²⁾	□ 23 ⇒ 40.0
E1 53	Coolant circulation pump (A31/1m1), overload ³⁾	□ 23 ⇒ 40.0

- 1) Observe Preparation for Test, see □ 22.
- 2) Continuous faults.
- 3) Intermittent faults.

Diagnosis - Diagnostic Trouble Code (DTC) Memory (Rear A/C)

Diagnostic Trouble Code (DTC)	Possible Cause	Test Step/Remedy ¹⁾
E1 56	Left duovalve (A31/1y1), short circuit ²⁾	□ 23 ⇒ 42.0
E1 57	Left duovalve (A31/1y1), short circuit ³⁾	□ 23 ⇒ 42.0
E1 58	Left duovalve (A31/1y1), open or short circuit ²⁾	□ 23 ⇒ 42.0
E1 59	Left duovalve (A31/1y1), open or short circuit ³⁾	□ 23 ⇒ 42.0
E1 60	Right duovalve (A31/1y2), short circuit ²⁾	□ 23 ⇒ 41.0
E1 61	Right duovalve (A31/1y2), short circuit ³⁾	□ 23 ⇒ 41.0
E1 62	Right duovalve (A31/1y2), open or short circuit ²⁾	□ 23 ⇒ 41.0
E1 63	Right duovalve (A31/1y2), open or short circuit ³⁾	□ 23 ⇒ 41.0
E1 64	Rear refrigerant shut-off valve (Y67), short circuit ²⁾	□ 23 ⇒ 39.0
E1 65	Rear refrigerant shut-off valve (Y67), short circuit ³⁾	□ 23 ⇒ 39.0
E1 66	Rear refrigerant shut-off valve (Y67), open or short circuit ²⁾	□ 23 ⇒ 39.0
E1 67	Rear refrigerant shut-off valve (Y67), open or short circuit ³⁾	□ 23 ⇒ 39.0
E1 68	Rear tunnel flap vacuum valve (Y67/1), short circuit ²⁾	□ 23 ⇒ 44.0
E1 69	Rear tunnel flap vacuum valve (Y67/1), short circuit ³⁾	□ 23 ⇒ 44.0
E1 70	Rear tunnel flap vacuum valve (Y67/1), open or short circuit ²⁾	□ 23 ⇒ 44.0
E1 71	Rear tunnel flap vacuum valve (Y67/1), open or short circuit ³⁾	□ 23 ⇒ 44.0

- 1) Observe Preparation for Test, see □ 22.
- 2) Continuous faults.
- 3) Intermittent faults.

Diagnosis - Diagnostic Trouble Code (DTC) Memory

**EZL / DI - Digital Ignition
(Pin #17)**

Diagnostic Trouble Code (DTC) Readout with Impulse Counter Scan Tool.

The DI control module (N1/3) is equipped with DTC readout including malfunction memory.

Malfunctions which occur with the engine running are counted by a malfunction counter. A malfunction is recorded into memory only if the same malfunction has occurred after 8 sequential engine starts.

This prevents a malfunction from being recorded if, for example, it occurred only once. If, for example, a malfunction occurred only 7 times, then the malfunction counter will be cleared again after a certain number of engine starts.

The memory remains active even if the vehicle's battery is disconnected.

Malfunctions occurring in the following areas are stored immediately:

- CKP sensor defective (diagnostic trouble code 17).
- Magnets for CKP sensor not recognized (diagnostic trouble code 18) (Engine 119 only).

Diagnosis - Diagnostic Trouble Code (DTC) Memory

Preparation for Test with Impulse Counter Scan Tool

- Connect impulse counter scan tool according to connection diagram (see section 0).
- Read DTC memory (see section 0).

Special Tools

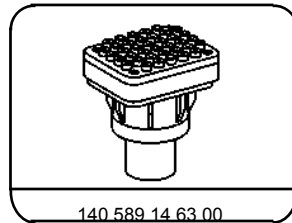
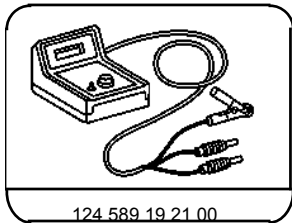

Diagnosis - Diagnostic Trouble Code (DTC) Memory

DTC	Possible cause	Test step/Remedy ¹⁾
1	No malfunction in system	-
2	Maximum retard setting on at least one cylinder has been reached	Increased knock tendency, i.e. due to poor fuel quality, carbon build-up, mechanical damage.
3	Not used	-
4	MAP sensor in DI control module (N1/3) defective	Check vacuum supply to N1/3, Replace N1/3.
5	Knock sensor 1 and/or 2 defective	Knock sensor not plugged in at N1/3, Replace knock sensor.
6	CMP sensor (L5/1) defective	□ 24 ⇒ 1.0
7	Knock control-output switch in DI control module (N1/3) defective	Replace N1/3.
8	Transmission overload protection switch (S65) does not close	□ 24 ⇒ 5.0
9	Transmission overload protection switch (S65) does not open	□ 24 ⇒ 6.0
10	Not used	-
11	Reference resistor (DI) (R16/2) defective	□ 24 ⇒ 4.0
12	TN-signal (engine rpm output) is outside of tolerance range	□ 24 ⇒ 7.0
13	Not used	-

¹⁾ Observe Preparation for Test, see □ 22.

Diagnosis - Diagnostic Trouble Code (DTC) Memory

DTC	Possible cause	Test step/Remedy ¹⁾
14	Not used	-
15	Ignition coil 1 output from DI control module (N1/3) defective or primary winding of ignition coil has open circuit	□ 23 ⇒ 7.0
16 119 only	Ignition coil 2 output from DI control module (N1/3) defective or primary winding of ignition coil has open circuit	□ 23 ⇒ 8.0
17	CKP sensor (L5) defective	□ 23 ⇒ 4.0
18 119 only	Magnets for CKP sensor (L5) not recognized	□ 23 ⇒ 5.0
19	Not used	-

20	DI control module (N1/3) DTC memory defective	Replace N1/3.
21	MAP sensor in DI control module (N1/3) defective (recognized with engine running)	Replace N1/3.
22	Not used	-
23	Not used	-
24	Not used	-
25	Not used	-
26	DI control module (N1/3) data exchange malfunction	<input type="checkbox"/> 24 ⇒ 8.0 - 9.0
27	LH-SFI control module (N3/1) data exchange malfunction	<input type="checkbox"/> 24 ⇒ 8.0
28	EA/CC/ISC control module (N4/1) data exchange malfunction	<input type="checkbox"/> 24 ⇒ 8.0

1) Observe Preparation for Test, see 22.

**EZL / DI - Digital Ignition
(Pin #17)**

Diagnosis - Diagnostic Trouble Code (DTC) Memory

DTC	Possible cause	Test step/Remedy ¹⁾
29	Not used	-
30	Not used	-
31	Not used	-
32	Not used	-
33	Not used	-
34	Ignition misfire cylinder 1 (engine 104) cyl. 1 (engine 119)	2)
35	Ignition misfire cylinder 5 (engine 104) cyl. 5 (engine 119)	2)
36	Ignition misfire cylinder 3 (engine 104) cyl. 4 (engine 119)	2)
37	Ignition misfire cylinder 6 (engine 104) cyl. 8 (engine 119)	2)
38	Ignition misfire cylinder 2 (engine 104) cyl. 6 (engine 119)	2)
39	Ignition misfire cylinder 4 (engine 104) cyl. 3 (engine 119)	2)
40 119 only	Ignition misfire cyl. 7 (engine 119)	2)
41 119 only	Ignition misfire cyl. 2 (engine 119)	2)

1) Observe Preparation for Test, see 22.

2) Spark plugs, ignition wire of respective cylinder, high-voltage distributor 23 = Test steps 11.0 - 12.0, ignition coil 23 = Test steps 9.0 - 10.0, DI control module.

Diagnosis - Diagnostic Trouble Code (DTC) Memory

Preparation for recalling diagnostic trouble code (DTC) memory

1. Connect impulse counter scan tool and adaptor for impulse counter scan tool to diagnostic connector (X11/4) according to connection diagram (see section 0).

LH-SFI control module	socket	4
Ignition control module	socket	17
EA/CC/ISC control module	socket	7

Note:

Connect impulse counter scan tool as follows:

red wire to socket 3,
black wire to socket 1 and
yellow wire to:

Diagnostic module	socket	19
Base module	socket	8

2. Recall control modules' diagnostic trouble code memory and clear stored trouble codes (see section 0).

**DM - Diagnostic Module
(Pin #19)**

Special Tools

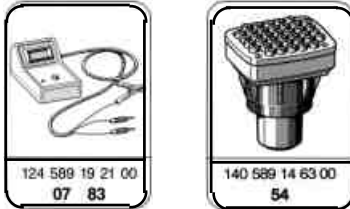

Diagnosis - Diagnostic Trouble Code (DTC) Memory

Diagnostic Trouble Code (DTC) Readout, Diagnostic Module

Diagnostic Trouble Code (DTC)	Possible Cause	Remedy/Test Step ¹⁾
1	No malfunction in systems monitored	-
2	Heated oxygen sensor inoperative	Test LH-SFI, section 3.1.
3	Lambda control inoperative	Test LH-SFI, section 3.1.
4	Air injection inoperative	Test LH-SFI, section 3.1.
5	Exhaust gas recirculation inoperative	Test LH-SFI, section 3.1.
6	Idle speed control inoperative	Test electronic accelerator, section 6.2.
7	Ignition system defective	Test distributor ignition system, section 5.2.
8	Engine coolant temperature sensor, open/short circuit	Test LH-SFI, section 3.1.
9	Intake air temperature sensor, open/short circuit	Test LH-SFI, section 3.1.
10	Voltage at mass air flow sensor too high/low	Test LH-SFI, section 3.1.
11	TN-signal (rpm) at LH-SFI control module (N3/1) defective	Test LH-SFI, section 3.1.
12	Heated oxygen sensor heater, open/short circuit	Test LH-SFI, section 3.1.
13	Camshaft position sensor signal of ignition control module defective.	Test LH-SFI, section 3.1.
14	Intake manifold pressure at start (in ignition control module - N1/3) too low/high	Vacuum supply to N1/3, test distributor ignition system, section 5.2.

¹⁾ Observe Preparation for Test, see □ 22.

Diagnosis - Diagnostic Trouble Code (DTC) Memory

Diagnostic Trouble Code (DTC)	Possible Cause	Remedy/Test Step ¹⁾
15	Wide open throttle information defective	Test electronic accelerator, section 6.2.
16	Closed throttle position information defective	Test electronic accelerator, section 6.2.
17	Data exchange malfunction between individual control modules	□ 23 ⇒ 7.0.
18	Adjustable camshaft timing solenoid, open/short circuit	Test LH-SFI, section 3.1.
19	Fuel injectors open/short circuit or emission control system adaptation in LH-SFI control module (N3/1) at limit	Test LH-SFI and reset LH-SFI control module adaptation to mean value, section 3.1.
20	Speed signal not present	Test electronic accelerator, section 6.2.
21	Purge switchover valve, open/short circuit	Test LH-SFI, section 3.1.
22	Camshaft position sensor signal defective	Test distributor ignition system, section 5.2.
23	Intake manifold pressure (in ignition control module - N1/3) with engine running too low/high	Vacuum supply to N1/3, test distributor ignition system, section 5.2.
24	Starter ring gear segments and/or crankshaft position sensor defective	Test distributor ignition system, section 5.2.
25	Knock sensors or ignition control module defective	Test distributor ignition system, section 5.2.
26	Upshift delay switchover valve, open/short circuit	Test LH-SFI, section 3.1.
27	Engine coolant temperature sensor deviation between sensor circuit 1 and sensor circuit 2	Test LH-SFI, section 3.1.
28	Engine coolant temperature sensor (engine coolant temperature change monitor)	Test LH-SFI, section 3.1.

Diagnosis - Fault memory

Prerequisites for reading out fault memory

1. Connect pulse counter or hand-held tester to data link connector (X11/4) according to connection schematic (see Index 0).

Note

1. Read out fault memory and note faults.
2. Eliminate faults noted according to fault table.
3. Interrupt power to PSE for approx. 3 s to erase safety memory.

**PSE - Pneumatic
System Equipment
(Pin #20)**

Special tools

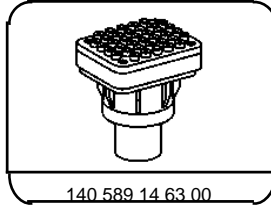
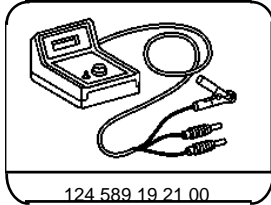

Diagnosis - Fault memory

Commercially available tools and test instruments, MB test instruments (see Workshop Equipment Manual)

Designation	Company	Order no.
Hand-held tester (HHT)	Mercedes-Benz AG VP/SDI 70322 Stuttgart	6511 0001 99
Test cable (multiplexer)	Mercedes-Benz AG VP/SDI 70322 Stuttgart	6511 0040 99

Diagnosis - Fault memory

Fault code	Possible causes	Remedy/Test step ¹⁾
1	No faults stored.	-
2	Central locking or trunk lid remote control air requirement too high.	<input type="checkbox"/> 32 PSE/CL or <input type="checkbox"/> 32 PSE/TRC
3	Retractable trunk lid grip or striker eye element ²⁾ , air consumption too high.	<input type="checkbox"/> 32 PSE/RTG
4	Backup assist, air consumption too high.	<input type="checkbox"/> 32 PSE/RFH
5	Pressure, orthopedic backrest, air consumption too high.	<input type="checkbox"/> 32 PSE/OSB
6	Vacuum, intake manifold vacuum increase or retractable rear head restraints, air consumption too high.	<input type="checkbox"/> 32 PSE/MVA or <input type="checkbox"/> 32 PSE/RHR
7	Lock switch 1 signal erroneous.	<input type="checkbox"/> 23 PSE/CL ⇒ 2.0, 3.0, 4.0
8	Lock switch 2 signal erroneous.	<input type="checkbox"/> 23 PSE/CL ⇒ 2.0, 3.0, 4.0
9	Retractable rear head restraint signal erroneous.	<input type="checkbox"/> 23 PSE/RHR ⇒ 1.0
10	Central locking system interior control signal erroneous.	<input type="checkbox"/> 23 PSE/CL ⇒ 1.0
11	Driver/passenger door contact signal erroneous.	<input type="checkbox"/> 23 PSE/CL ⇒ 5.0
12	Lock switch 1 signal present longer than 2 min.	<input type="checkbox"/> 23 PSE/CL ⇒ 2.0, 3.0, 4.0
13	Lock switch 2 signal present longer than 2 min.	<input type="checkbox"/> 23 PSE/CL ⇒ 2.0, 3.0, 4.0
14	Central locking system interior control signal present longer than 2 min.	<input type="checkbox"/> 23 PSE/CL ⇒ 1.0
15	Retractable rear head restraint signal present longer than 2 min.	<input type="checkbox"/> 23 PSE/RHR ⇒ 1.0

¹⁾ Observe prerequisites for testing.

²⁾ Only vehicles with power locking as of vehicle ident. end no. 118 121

Diagnosis - Diagnostic Trouble Code (DTC) Memory

Preparation for Test:

- Check fuse F4-11.
- Check fuse F3-35.
- Connect impulse counter scan tool or Hand-Held Tester (HHT) to 38-pole data link connector (X11/4) according to connection diagram shown in section 0.

Note:

Connect yellow wire of impulse counter scan tool to socket 21.

Electrical wiring diagrams

See Electrical Troubleshooting Manual, Model 140, Volume 2.

Convenience
System
(Pin #21)

Special Tools

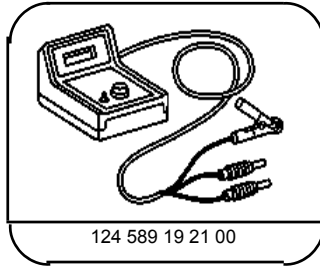

124 589 19 21 00

Pulse counter

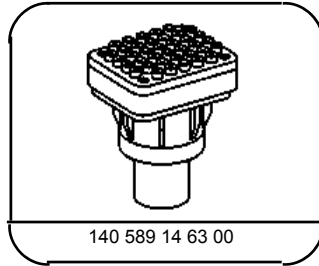

140 589 14 63 00

Adapter

Diagnosis - Diagnostic Trouble Code (DTC) Memory

Diagnostic trouble code (DTC)	Possible cause	Test step/Remedy ¹⁾
1 001	No malfunction in memory.	-
2 002	Closing circuit for left front power window motor (M10/3), control module (N57).	□ 23 ⇒ 1.0, 29
3 003	Opening circuit for left front power window motor (M10/3), control module (N57).	□ 23 ⇒ 1.0, 29
4 004	Closing circuit for right front power window motor (M10/4), control module (N57).	□ 23 ⇒ 2.0, 30
5 005	Opening circuit for right front power window motor (M10/4), control module (N57).	□ 23 ⇒ 2.0, 30
6 006	Closing circuit for left rear power window motor (M10/5), control module (N57).	□ 23 ⇒ 2.0, 31
7 007	Opening circuit for left rear power window motor (M10/5), control module (N57).	□ 23 ⇒ 2.0, 31
8 008	Closing circuit for right rear power window motor (M10/6), control module (N57).	□ 23 ⇒ 1.0, 32
9 009	Opening circuit for right rear power window motor (M10/6), control module (N57).	□ 23 ⇒ 1.0, 32
10 010	Switch for left front power window (S21/1): closing time exceeded.	□ 23 ⇒ 11.0, 13.0
11 011	Switch for left front power window (S21/1): opening time exceeded.	□ 23 ⇒ 10.0, 12.0
12 012	Switch for right front power window (S21/2): closing time exceeded.	□ 23 ⇒ 15.0, 17.0

¹⁾ Observe Preparation for Test, see □ 22.

Diagnosis - Diagnostic Trouble Code (DTC) Memory

Diagnostic trouble code (DTC)	Possible cause	Test step/Remedy ¹⁾
13 013	Switch for right front power window (S21/2): opening time exceeded.	□ 23 ⇒ 14.0, 16.0
14 014	Left rear power window circuit (S21/3) and left rear power window switch, front console (S21/5): closing time exceeded.	□ 23 ⇒ 19.0, 21.0
15 015	Left rear power window circuit (S21/3) and left rear power window switch, front console (S21/5): opening time exceeded.	□ 23 ⇒ 18.0, 22.0
16 016	Right rear window circuit (S21/4) and right rear power window switch, front console (S21/6): closing time exceeded.	□ 23 ⇒ 23.0, 25.0
17 017	Right rear window circuit (S21/4) and right rear power window switch, front console (S21/6): opening time exceeded.	□ 23 ⇒ 22.0, 24.0
18 018	Circuit for left front (S86/1), right front (S87/1), trunk lid (S88/2) lock switch: closing time exceeded (lock switch circuit 2).	□ 23 ⇒ 27.0
19 019	Circuit for left front (S86/1), right front (S87/1), trunk lid (S88/2) lock switch: opening time exceeded (lock switch circuit 1).	□ 23 ⇒ 27.0
20 020	Left front power window switch (S21/1): short to ground or wiring.	□ 23 ⇒ 10.0 - 13.0
21 021	Right front power window switch (S21/2): short to ground or wiring.	□ 23 ⇒ 14.0 - 17.0
22 022	Left rear window circuit (S21/3) and left rear power window switch, front console (S21/5): short to ground or wiring.	□ 23 ⇒ 18.0 - 21.0
23 023	Right rear window circuit (S21/4) and right rear power window switch, front console (S21/6): short to ground or wiring.	□ 23 ⇒ 22.0 - 25.0

¹⁾ Observe Preparation for Test, see □ 22.

Diagnosis - Diagnostic Trouble Code (DTC) Memory

Diagnostic trouble code (DTC)	Possible cause	Test step/Remedy ¹⁾
24 U24	Left front power window motor circuit (M10/3): speed sensor or wiring	□ 23 ⇒ 29.0
25 U25	Right front power window motor circuit (M10/4): speed sensor or wiring.	□ 23 ⇒ 30.0
26 U26	Left rear power window motor circuit (M10/5): speed sensor or wiring.	□ 23 ⇒ 31.0
27 U27	Right rear power window motor circuit (M10/6): speed sensor or wiring.	□ 23 ⇒ 32.0
28 U28	Left front power window motor circuit (M10/3): sensor wiring reversed.	-
29 U29	Right front power window motor circuit (M10/4): sensor wiring reversed.	-
30 U30	Left rear power window motor circuit (M10/5): sensor wiring reversed.	-
31 U31	Right rear power window motor circuit (M10/6): sensor wiring reversed.	-
32 U32	Left front power window motor circuit (M10/3): speed sensor signal defective.	□ 23 ⇒ 29.0
33 U33	Right front power window motor circuit (M10/4): speed sensor signal defective.	□ 23 ⇒ 30.0
34 U34	Left rear power window motor circuit (M10/5): speed sensor signal defective.	□ 23 ⇒ 31.0
35 U35	Right rear power window motor circuit (M10/6): speed sensor signal defective.	□ 23 ⇒ 32.0
36 U36	Control module (N57) defective.	-
37 U37	Low voltage (<9 V) (circuit 30E, fuse F4-11).	□ 23 ⇒ 3.0
38 U38	Sliding/pop-up roof switch circuit (S13/2): short, check wiring harness.	□ 23 ⇒ 6.0 - 9.0
39 U39	Voltage supply circuit 30A, control module (N57).	□ 23 ⇒ 1.0
40 U40	Voltage supply circuit 30B, control module (N57).	□ 23 ⇒ 2.0

¹⁾ Observe Preparation for Test, see □ 22.

**Convenience
System
(Pin #21)**

Diagnosis - Diagnostic Trouble Code (DTC) Memory

Preparation for Test

1. Connect impulse counter scan tool or Hand-Held Tester (HHT) according to connection diagram (see section 0).

Electrical wiring diagrams:

Electrical Troubleshooting Manual, Model 140, Volume 2, group 80 and 82.

Note:

ATA deactivated.

Connect yellow wire to socket 23 of 38-pole data link connector (X11/4).

DTC readout begins with the most current fault and ends with the oldest

logic: last in, first out).

ATA
Anti-Theft Alarm
(Pin #23)

Diagnosis - Diagnostic Trouble Code (DTC) Memory

DTC		Possible cause	Test step/Remedy ¹⁾
1	001	No DTC stored in system.	
2	002	ATA activated via rotary tumbler/ trunk lid microswitch (S88/1)	□ 23 ⇒ 7.0
3	003	ATA activated via engine hood switch (S62)	□ 23 ⇒ 8.0
5	005	ATA activated via left/right rear door switch (S17/5, S17/6)	□ 23 ⇒ 5.0
6	006	ATA activated via left/right door switch (S17/3, S17/4)	□ 23 ⇒ 6.0
7	007	Not applicable for U.S.A. vehicles	-
8	008	Not applicable for U.S.A. vehicles	-
10	010	ATA activated via radio (A2) (radio contact) (running change during M.Y. 1996)	□ 23 ⇒ 10.0
12	012	ATA activated via ignition (S2/1)	□ 23 ⇒ 11.0
14	014	ATA activated via brake switch (S9/1)	□ 23 ⇒ 9.0
15	015	Not applicable for U.S.A. vehicles	-
16	016	Not applicable for U.S.A. vehicles	-
17	017	Not applicable for U.S.A. vehicles	-
18	018	Not applicable for U.S.A. vehicles	-
19	019	ATA control module (N26)	N26

¹⁾ Observe Preparation for Test, see □ 22.

Diagnosis - Diagnostic Trouble Code (DTC) Memory

DTC		Possible cause	Test step/Remedy ¹⁾
20	020	Left front door actuator (S47), no ground	□ 23 ⇒ 12.0
21	021	Temec control modules only Starter lock-out relay module (K38) shorted to circuit 30 in armed status	□ 23 ⇒ 25.0
21	021	Becker control modules only ATA status indicator lamp (E33) shorted to circuit 30	□ 23 ⇒ 15.0
22	022	Becker control modules only Starter lock-out relay module (K38) shorted to circuit 30 in armed status	□ 23 ⇒ 25.0
22	022	Temec control modules only Open circuit to circuit 30 in armed status	□ 23 ⇒ 1.0
23	023	Becker control modules only Open circuit to circuit 30 in armed status	□ 23 ⇒ 1.0

¹⁾ Observe Preparation for Test, see □ 22.

Diagnosis - Diagnostic Trouble Code (DTC) Memory (driver/passenger-side airbag)

Preliminary work:

Diagnosis - Function Test□ 11

SRS - Airbag
Through Model Year 1993
(Pin #30)

Preparations for DTC readout

- Fuses F3-15 O.K.
- Connect impulse counter scan tool to data link connector (X11/4) according to connection diagram (see section 0).
yellow wire to socket 30
- The 12-pole SRS test connection (X11/13) must be connected, for DTC.

Special Tools

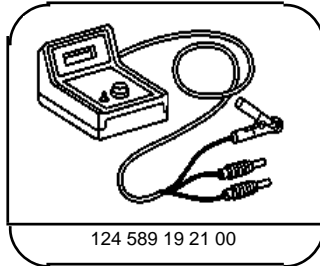

124 589 19 21 00

Pulse counter

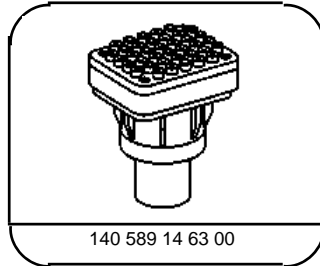

140 589 14 63 00

Adapter

Diagnosis - Diagnostic Trouble Code (DTC) Memory (driver/passenger-side airbag)

Diagnostic trouble code (DTC) □	Possible cause	Test step/Remedy ¹⁾
1	No fault recognized in system	-
2	SRS control module (N2/2)	□ 23 ⇒ 2.0
3	Driver airbag squib (R12/3)	□ 23 ⇒ 3.0, 9.0
4	Front passenger airbag squibs (R12/8)	□ 23 ⇒ 4.0, 10.0
5	Left front seat belt buckle switch (S68/3)	□ 23 ⇒ 5.0
6	Right front seat belt buckle switch (S68/4)	□ 23 ⇒ 6.0
7	Front passenger airbag resistance	□ 23 ⇒ 7.0
8	Voltage supply circuit 15R	□ 23 ⇒ 1.0
9	SRS malfunction indicator lamp (A1e15) or time limit for DTC readout /erasing exceeded	□ 23 ⇒ 8.0
10 ²⁾	SRS control module (N2/2)	N2/2 (SMS, Job No. 91-622)

¹⁾ Observe Preparation for Test, see □ 22.

²⁾ DTC 10 indicates that the airbag deployment stage was activated in the control module. This DTC can not be erased.

The control module must be replaced.

IMPORTANT NOTE!

Before replacing the SRS control module (N2/2) in cases of DTC 10 without an airbag deployment, reposition airbag harness ground connections to lowest terminal connection.

Note:

The ETR's are not included in the DTC readout, if DTC 3 and/or 4 can not be erased, see ETR Test □ 32 ⇒ 1.0 and 2.0 ¹⁾.

Diagnosis - Diagnostic Trouble Code (DTC) Memory (driver/passenger-side airbag/side airbag)

CAUTION!

Risk of Injury when performing Diagnostic Tests and repairs on components of the SRS system.

Store both airbags and side airbags with opening surface pointing upward.

Do not expose to temperatures above 100°C.

Interrupt any electrical current from reaching the airbag unit.

SRS - Airbag
As of Model Year 1994
(Pin #30)

CAUTION!

Risk of injury if airbag units and ETR units are ignited accidentally or if stored with the opening end facing downward which may cause the accidentally ignited components to fly about causing injury. Danger to persons also exists if the components are disposed of by cutting apart with cutting torches or other cutting/separation devices. Danger also exists if disposing of the untriggered units via refuse collection or via smelting/carbonizing companies.

Protective measures/Supervision

- Place removed airbag unit with the opening side facing upward.
- Allow only **properly trained dealer staff** to supervise, purchase, transport, store, test/replace any of the SRS components.
- Install all airbag or ETR units once pulled from the parts department.
- Protect all airbag or ETR units from any sparks, open flame, or temperatures above 100°C.
- Do not transport airbag or ETR units in the passenger compartment, rather transport securely in their **original packaging** in the trunk.
- Do not allow oil, grease or cleaning agents come in contact with the airbag or ETR units
- Perform SRS tests only with approved test equipment (such as HHT), while installed in the vehicle **without** occupants.

- When reconnecting the vehicle battery or any outside electrical source, with the ignition turned ON, do not allow any occupants inside the vehicle.
- Airbag or ETR units which have been dropped from a height greater than 18 inches must be replaced.
- Prior to disposing the airbag or ETR units, the units must be made un-useable by discharging.
- In order to render the airbag and ETR unit un-useable, the specially made discharge harness must be used and at the same time maintain a **safe distance of at least 33 feet** from the units being discharged.

Prior to undertaking any chassis/body repairs, installation/repair work on airbag and ETR units, or any components which come in contact with the airbag and ETR units, or are part of the electrical circuit of airbag and ETR units (such as installation of the steering wheel), the following conditions must be met:

- Remove ignition key.
- Disconnect any outside source of electrical circuit (i.e. battery charger).
- When performing interior repairs or welding operations, disconnect the connector from the SRS control module.

Diagnosis - Diagnostic Trouble Code (DTC) Memory (driver/passenger-side airbag/side airbag)

Preliminary work:

Diagnosis - Function Test □ 11

Preparation for DTC readout

1. Review □ 11, □ 12, □ 13, □ 20, □ 21, □ 22, □ 23, □ 31, □ 32
2. Fuses OK.
3. Battery voltage 11 - 14 V
4. SRS MIL (A1e15) illuminates.
5. Connect Hand-Held Tester (HHT) as per connection diagram, see section 0, and readout DTC memory.

CAUTION!

Do not connect battery trickle charger.

CAUTION!

Risk of Injury when performing Diagnostic Tests and repairs on components of the SRS system.

Store both airbags and side airbags with opening surface pointing upward.

Do not expose to temperatures above 100°C.

Interrupt any electrical current from reaching the airbag unit.

Note:

As of 07/93, diagnostic trouble codes (DTC's) can only be read out and erased **using the Hand-Held Tester (HHT)**.

Determine MB number of the SRS control module via HHT (see DTC chart on page 12/3):

The SRS control modules beginning with the number **000**, the fault code **1** is valid.

Those beginning with **001**, the fault code **2** is valid.



When installing additional accessories, observe harness clearances near SRS sensor lines.

DTC's for Lower Control Field Control Module (N72) see □ 12/6

Test equipment; See MBNA Standard Service Equipment Program

Hand-Held Tester (HHT) ^{†)}

See S.I. in groups 58 and 99.

^{†)} Available through the MBNA Standard Equipment Program.

Diagnosis - Diagnostic Trouble Code (DTC) Memory (driver/passenger-side airbag/side airbag)



A current fault is indicated by the DTC being highlighted in black.

Additional detailed information is given with most DTC's, which will indicate possible faults conditions or portions thereof:

- > Ω Resistance too great.
- < Ω Resistance too low.
- Γ- Short circuit to ground (GND)
- Γ+ Short circuit to positive (POS).
- /- Open circuit.

Fault frequency and time span of the fault can be read by pressing the  key.

Fault frequency:

Faults are noted by frequency of occurrence, i.e.: 5 periodic faults, 5 occurrences, eliminated 5 times.

Time span:

The amount of time elapsed since last fault, or since fault eliminated itself.





Diagnosis - Diagnostic Trouble Code (DTC) Memory (driver/passenger-side airbag/side airbag)

DTC with fault code 1	with fault code 2	Possible cause	Test step/Remedy ¹⁾
001	001	SRS control module (N2/2)	□ 23 ⇒ 2.0
002	004	Driver AB squib (R12/3)	□ 23 ⇒ 3.0, 4.0
003	005	Left front ETR squib (R12/1)	□ 23 ⇒ 5.0, 6.0
004	006	Right front ETR squib (R12/2)	□ 23 ⇒ 7.0, 8.0
005	007	Front passenger AB squib (R12/8)	□ 23 ⇒ 9.0, 10.0
	008	Left side airbag squib (R12/9)	□ 23 ⇒ 15.0, 16.0
	009	Right side airbag squib (R12/10)	□ 23 ⇒ 17.0, 18.0
010	004-009 016, 017 026, 029 034	Programming does not comply with vehicle version	□ 31.0, verify vehicle version, repeat programming.
017	003	Circuit 15R, voltage supply (low voltage)	□ 23 ⇒ 1.0
019	002	SRS MIL (A1e15)	□ 23 ⇒ 11.0
020	025	Front passenger seat occupied recognition sensor (B41/1) ²⁾ or (B48)	□ 23 ⇒ 19.0

1) Observe Preparation for Test, see □ 22.

2) As of model introduction , other models as of approx. 06/96

Diagnosis - Diagnostic Trouble Code (DTC) Memory (driver/passenger-side airbag/side airbag)

DTC with fault code 1	with fault code 2	Possible cause	Test step/Remedy ¹⁾
024 	016 	Left front seat belt buckle switch (AB/ETR) (S68/3)	□ 23 ⇒ 12.0
025 	017 	Right front seat belt buckle switch (AB/ETR) (S68/4)	□ 23 ⇒ 13.0
073		Squib short circuit (Γ1) (to each other)	□ 23 ⇒ 14.0
	018	Left side airbag (A53), harness fault	□ 23 ⇒ 16.0
	019	Left side air bag (A53), sensor defective	Replace sensor
	020	Left side air bag (A53), sensor defective	Replace sensor
	021	Right side airbag (A54)	□ 23 ⇒ 18.0
	022	Right side airbag (A54), sensor defective	Replace sensor
	023	Right side airbag (A54), sensor defective	Replace sensor
	027	Front passenger seat occupied recognition with automatic child seat recognition (B48) (ACSR), communication, -/-, Γ1	□ 23 ⇒ 20.0
	028	Front passenger seat occupied recognition with automatic child seat recognition (B48) (ACSR), Improperly positioned child seat or faulty, Connection between passenger seat and child seat faulty, B48, Metallic objects on passenger seat or child seat, Short term electromagnetic interference in immediate area such as electronic transmitters, telephones etc.	Position child seat properly or replace, Replace B48

1) Observe Preparation for Test, see □ 22.

Diagnosis - Diagnostic Trouble Code (DTC) Memory (driver/passenger-side airbag/side airbag)

DTC with fault code 1	with fault code 2	Possible cause	Test step/Remedy ¹⁾
	031	Front passenger seat occupied recognition with automatic child seat recognition (B48) (ACSR)	Replace B48
	032	Left side airbag (A53), communication interference	Electromagnetic interference, check harness routing if accessories installed ²⁾
	033	Right side airbag (A54), communication interference	Electromagnetic interference, check harness routing if accessories installed ²⁾
	034	Digital crash output, harness fault (TELE AID) ³⁾	

- 1) Observe Preparation for Test, see □ 22.
- 2) Observe clearances near sensors, if additional accessories are being installed.
- 3) Currently only on model 170

Diagnosis - Diagnostic Trouble Code (DTC) Memory (driver/passenger-side airbag/side airbag)

⚠ CAUTION!

Risk of Injury when performing Diagnostic Tests and repairs on components of the SRS system.

Store both airbags and side airbags with opening surface pointing upward. Do not expose to temperatures above 100°C.

Interrupt any electrical current from reaching the airbag unit.

SRS - Airbag
As of Model Year 1994
(Pin #30)

⚠ CAUTION!

Risk of injury if airbag units and ETR units are ignited accidentally or if stored with the opening end facing downward which may cause the accidentally ignited components to fly about causing injury. Danger to persons also exists if the components are disposed of by cutting apart with cutting torches or other cutting/separation devices. Danger also exists if disposing the untriggered units via refuse collection or via smelting/carbonizing companies.

Protective measures/Supervision

- Place removed airbag unit with the opening side facing upward.
- Allow only **properly trained dealer staff** to supervise, purchase, transport, store, test/replace any of the SRS components.
- Install all airbag or ETR units once pulled from the parts department.
- Protect all airbag or ETR units from any sparks, open flame, or temperatures above 100°C.
- Do not transport airbag or ETR units in the passenger compartment, rather transport securely in their **original packaging** in the trunk.
- Do not allow oil, grease or cleaning agents come in contact with the airbag or ETR units
- Perform SRS tests only with approved test equipment (such as HHT), while installed in the vehicle **without** occupants.

- When reconnecting the vehicle battery or any outside electrical source, with the ignition turned ON, do not allow any occupants inside the vehicle.
- Airbag or ETR units which have been dropped from a height greater than 18 inches must be replaced.
- Prior to disposing the airbag or ETR units, the units must be made un-useable by discharging.
- In order to render the airbag and ETR unit un-useable, the specially made discharge harness must be used and at the same time maintain a **safe distance of at least 33 feet** from the units being discharged.

Prior to undertaking any chassis/body repairs, installation/repair work on airbag and ETR units, or any components which come in contact with the airbag and ETR units, or are part of the electrical circuit of airbag and ETR units (such as installation of the steering wheel), the following conditions must be met:

- Remove ignition key.
- Disconnect any outside source of electrical circuit (i.e. battery charger).
- When performing interior repairs or welding operations, disconnect the connector from the SRS control module.

Preparation for DTC readout for Lower Control Field Control Module (N72) follows on next page.

Diagnosis - Diagnostic Trouble Code (DTC) Memory (driver/passenger-side airbag/side airbag)

Preparation for DTC readout for Lower Control Field Control Module (N72) only

1. Connect Hand-Held Tester (HHT) as per connection diagram, see section 0, and readout DTC memory for lower control field control module (N72),
2. Review □ 12, □ 13,
2. Listed below are only the DTC's pertaining to SRS,
3. Fuses OK,
4. Battery voltage 11 - 14 V,
5. SRS MIL (A1e15) illuminates.

DTC	Possible cause	Test step/Remedy ¹⁾
B 1558	Automatic child seat recognition warning lamp (N72e1) ΓΓ- short circuit to ground, -/- open circuit	□ 23 ⇒ 22.0
B 1559	ACSR signal line ΓΓ- short circuit to ground	□ 23 ⇒ 20.0

- 1) Observe Preparation for Test, see □ 22.

Diagnosis - Diagnostic Trouble Code (DTC) Memory

Preliminary work:

Function check □ 11

Preparation for Test:

- Connect impulse counter scan tool or Hand-Held Tester (HHT) to 38-pole data link connector (X11/4) according to connection diagram shown in section 0.

Note:

Connect yellow wire of impulse counter scan tool to socket 31.

Electrical wiring diagrams

See Electrical Troubleshooting Manual, Model 140, Volume 2.

IRCL
Infrared Remote
Central Locking
(Pin #31)

Special Tools

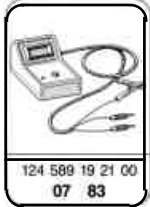

Equipment

Hand-held Tester (HHT)¹⁾

See applicable Service Information in groups 58 and 99.

Diagnosis - Diagnostic Trouble Code (DTC) Memory

Diagnostic trouble code (DTC)	Possible cause	Test step/Remedy ¹⁾
1 001	No malfunction in memory.	2)
2 002	Open circuit - left front door actuator.	□ 23 ⇒ 2.0
3 003	Warning buzzer - open circuit.	□ 23 ⇒ 6.0
4 004	Warning buzzer - short circuit to ground.	□ 23 ⇒ 6.0
5 005	Red indicator lamps - short to ground.	□ 23 ⇒ 11.0, 16.0, 21.0
6 006	Green indicator lamps - short to ground.	□ 23 ⇒ 12.0, 17.0, 22.0
7 007	Short to positive, lock circuit 1	□ 23 ⇒ 8.0, 13.0, 18.0
8 008	Short to positive, lock circuit 2	□ 23 ⇒ 8.0, 13.0, 18.0
9 009	Red indicator lamps - short to positive.	□ 23 ⇒ 11.0, 16.0, 21.0
10 010	Green indicator lamps - short to positive.	□ 23 ⇒ 12.0, 17.0, 22.0
11 011	IRCL control module (N54).	N54
12 012	Immobilization output, short after circuit 30.	□ 23 ⇒ 23.0

1) Observe Preparation for Test, see □ 22.

2) If the diagnostic trouble code □ !" (no malfunction in memory) appears, but the vehicle cannot be locked or unlocked from either door or trunk lid, perform Function Test, Test steps 1 - 9 with the second infrared transmitter. If the infrared remote control functions with the second transmitter, replace the first transmitter. If the infrared remote control does not function with the second transmitter, perform □ Test" (□ 23).