

MODEL 210 up to 30.6.99

**i** In vehicles up to vehicle identification end no. 210 1A 18 000 the mounting bracket (arrow) on the right front transverse control arm may be missing. With these vehicles, the transverse control arm must be replaced and the vehicle then aligned.

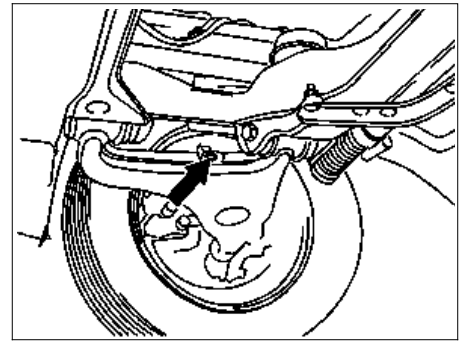

P82.10-0478-13

- A51 Headlamp range adjustment rear axle sensor
- A52 Front axle sensor (headlamp range adjustment)
- E1 Left lamp unit
- E2 Right lamp unit
- F1-15 Fuse 15, circuit 15
- N7-1 Light module
- N71 Headlamp range adjustment control unit
- W15/1 Ground (right footwell)
- X11/4 Diagnostic data link connector
- X62/21 Terminal block (left rear speed signal sensor - ASR/ETS)

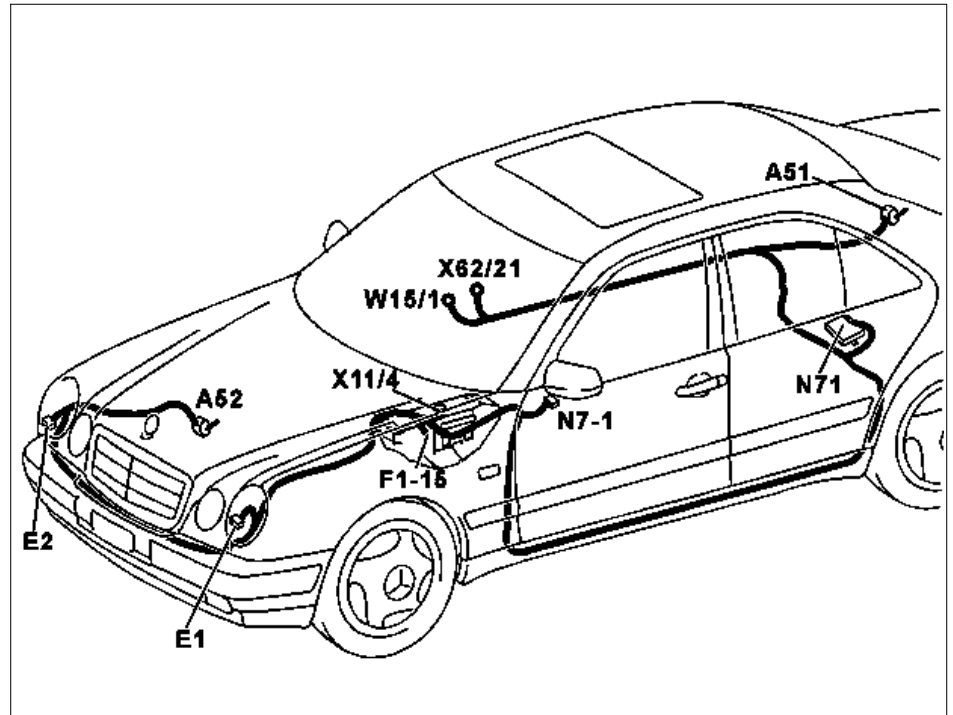

P82.10-0476-57



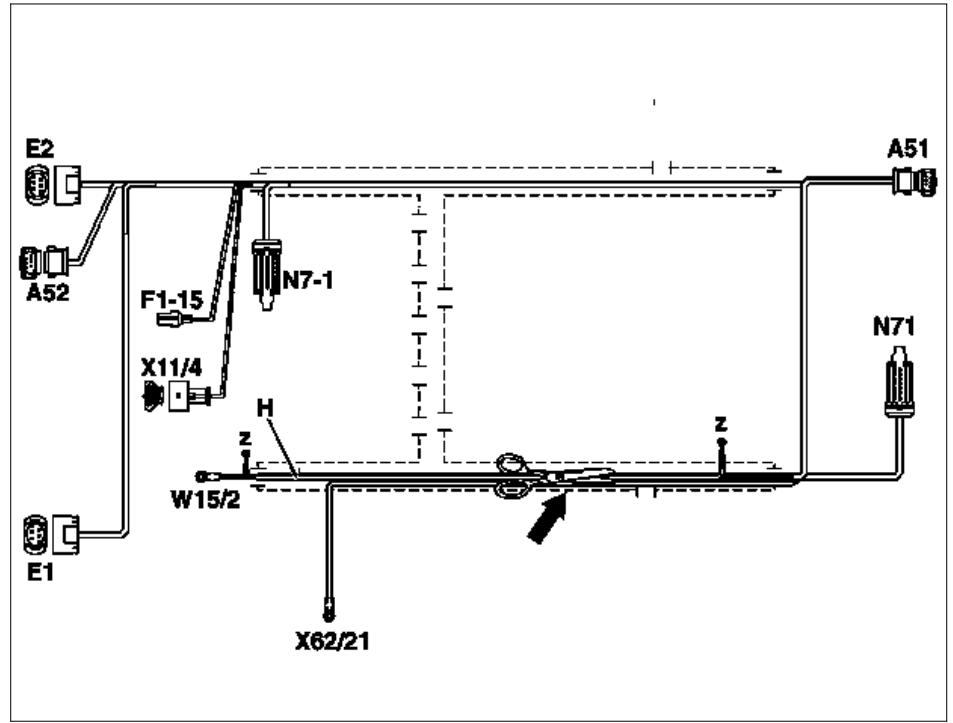

**Model 210 right-hand drive sedan**

- H Extended line
- z Terminal block
- A51 Headlamp range adjustment rear axle sensor
- A52 Front axle sensor (headlamp range adjustment)
- E1 Left lamp unit
- E2 Right lamp unit
- F1-15 Fuse 15, circuit 15
- N7-1 Light module
- N71 Headlamp range adjustment control unit
- W15/2 Ground (left footwell)
- X11/4 Diagnostic data link connector
- X62/21 Terminal block (left rear speed signal sensor - ASR/ETS)



P82.10-0539-57

	<p><b>Removal</b></p>		
<p><b>⚠ Danger!</b></p>	<p><b>Risk of death</b> caused by high voltage levels present at xenon headlamps.  <b>Risk of explosion/risk of fire</b> due to highly flammable materials in the area of damaged xenon bulbs  <b>Risk of injury</b> from UV light, hot components at xenon headlamps and glass splinters when xenon bulbs crack  <b>Risk of poisoning</b> from inhaling mercury vapors and from swallowing/skin contact with poisonous salts and mercury compounds</p>	<p>Do not come into contact with parts that are under high voltage. Persons with <b>active electronic implants</b> (e.g. heart pacemakers) must never work on xenon headlamps. Switch off entire lighting system. Wear insulating safety shoes, safety glasses and protective gloves. Remove highly inflammable materials from the hazard area. Ensure the work area is adequately ventilated.</p>	<p>AS82.10-Z-0001-01A</p>
<p></p>	<p>Retrofit xenon headlamps</p>	<p>Model 129, 140, 202, 210, 220</p>	<p>AH82.10-P-1003-01A</p>
<p>1  <b>AR</b></p>	<p>Disconnect ground line of battery</p>		<p>AR54.10-P-0003A</p>
<p>2.1</p>	<p>Fold forward rear seat cushions</p>	<p> Model 210.2 only</p>	
<p>2.2  <b>AR</b></p>	<p>Remove rear seat cushion Remove/install rear seat and rear seat backrest</p>	<p> Model 210.0 only  Only remove rear seat cushion.</p>	<p>AR91.12-P-1700F</p>
<p>3</p>	<p>Remove lower paneling from left A-pillar</p>		
<p>4</p>	<p>Remove lower paneling from left and right B-pillars</p>		
<p>5</p>	<p>Remove left front carpeting</p>		
<p>6</p>	<p>Remove door sill moldings from left and right front and rear door</p>		
<p>7</p>	<p>Open left and right cable duct cover</p>		
<p>8</p>	<p>Remove left footrest</p>		
<p>9  <b>AR</b></p>	<p>Remove light module</p>		<p>AR54.25-P-3260A</p>
<p>10.1</p>	<p>Unfasten windshield washer fluid reservoir and place to one side</p>		
<p>11  <b>AR</b></p>	<p>Remove headlamp</p>		<p>AR82.10-P-4730EB</p>
<p>12</p>	<p>Remove air filter housing</p>		
<p>13</p>	<p>Slacken coolant expansion reservoir and place to the side</p>	<p> Do not disconnect coolant hose.</p>	
<p>14</p>	<p>Remove plastic protective grille in front of condenser</p>	<p> If installed.</p>	

15	Remove engine compartment paneling at bottom or soundproofing		
	<b>Install</b>		
16	Install headlamp range adjustment wiring harness		AN82.10-P-0002-03FF
17	Retrofit headlamp range adjustment rear axle sensor		AN82.10-P-0003-01FF
18	Retrofit headlamp range adjustment front axle sensor		AN82.10-P-1000-01FF
19	Retrofit headlamp cleaning system	See installation instructions.	AN82.15-P-0001A
20	Install in the reverse order	 Operation step 15 - 1	
21	Carry out function check		
22	Check headlamp adjustment	 <b>Do not switch on light, risk of being dazzled!</b>	
23	Set zero position of headlamps using HHT	refer to Diagnosis Manual, Body	
24	When modifying the package, subsequently enter code or designation of corresponding special equipment on vehicle data card and FDOK	 Code 612	

#### Parts ordering notes

Part no.	Designation	Quantity
DG 99	Xenon headlights parts kit	1
Commercially available	Brown line 1.5 mm <sup>2</sup>	1,8 M

- 1 Prepare wiring harness as shown in illustration.

H Extended cable  
z Cable connector

A51 Headlamp range adjustment rear axle sensor

A52 Headlamp range adjustment front axle sensor

E1 Left headlamp unit

E2 Right headlamp unit

F1-15 Fuse 15, circuit 15

N7-1 Light module

N71 Headlamp range adjustment control module

W15/1 Ground, right footwell

X11/4 Datalink connector

X62/21 ASR wheel speed signal/ electronic traction system (ETS) rear left cable connector

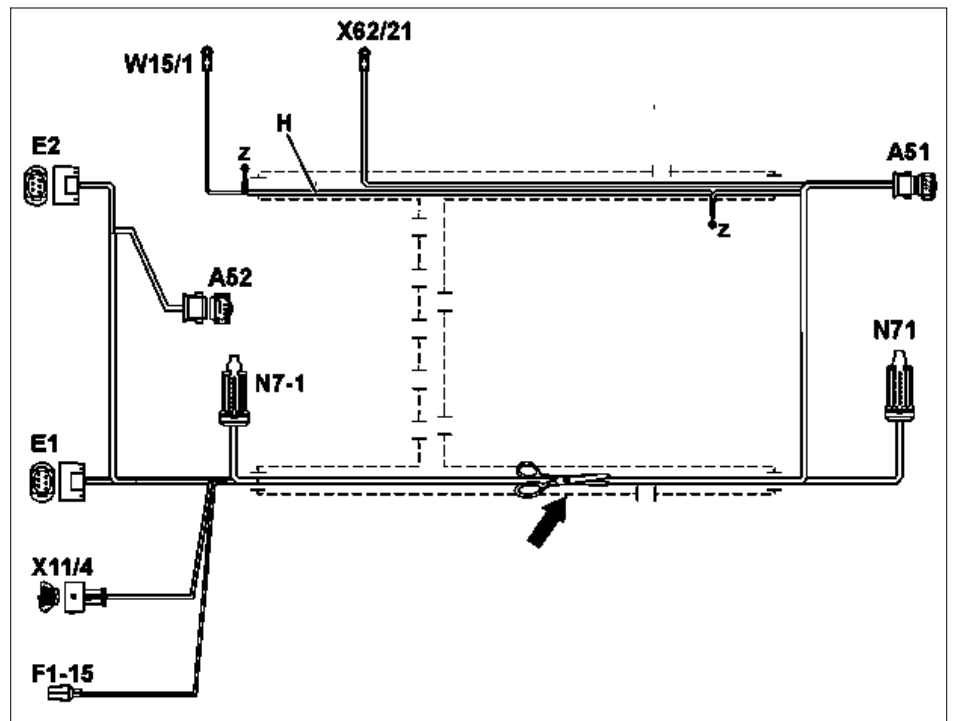

P82.10-0474-57

- 2 Modify wiring harness as shown in illustration. Cut open wiring harness insulation for this step (arrow).

- 3 Cut through brown cable about 10 cm behind the round cable lug and strip insulation on both sides over about 15 mm.

- 4 Cut commercially available brown cable with cross-section of 1.5 mm<sup>2</sup> to length of 1.8 m and strip insulation at both sides over about 15 mm.

- 5 Turn cable with round cable lug and brown cable together and solder together with cable connector (Z).

- 6 Connect other ends of the brown cables with cable connector (Z) as described in steps 3-4.

- 7 Re-enclose wiring harness with PVC insulating tape.

- 8 Route wiring harness of xenon headlamps in vehicle as shown in the illustration.

A51 Headlamp range adjustment rear axle sensor

A52 Headlamp range adjustment front axle sensor

E1 Left headlamp unit

E2 Right headlamp unit

F1-15 Fuse 15, circuit 15

N7-1 Light module

N71 Headlamp range adjustment control module

W15/1 Ground, right footwell

X11/4 Datalink connector

X62/21 ASR wheel speed signal/ electronic traction system (ETS) rear left cable connector

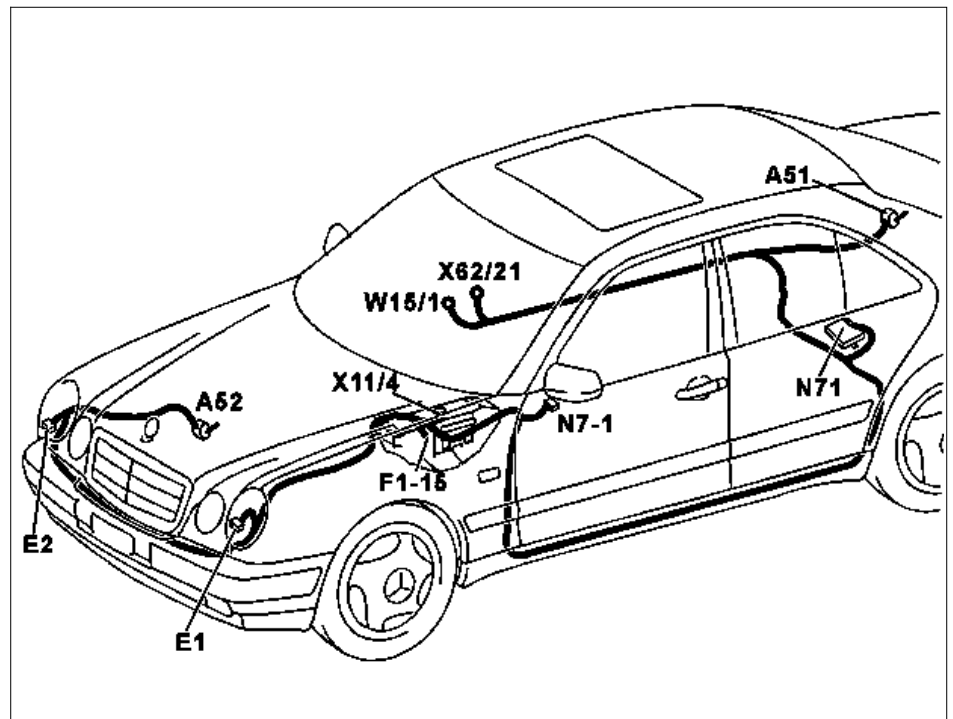

P82.10-0476-57

- 9 Route black/purple and purple cables into the fuse and relay box (F1).
- 10 Connect black/purple cable to fuse box receptacle "A" assignment 15.
- 11 Insert 15A fuse at fuse carrier assignment 15.
- 12 Insert purple cable at data link connector (X11/4) receptacle 35.
- 13 Route 6-pin sockets (3 in total) from interior through the fuse and relay box (F1) into the engine compartment.

**i** Remove grommet of wiring harness; is not required.

F1-15 Fuse 15, circuit 15

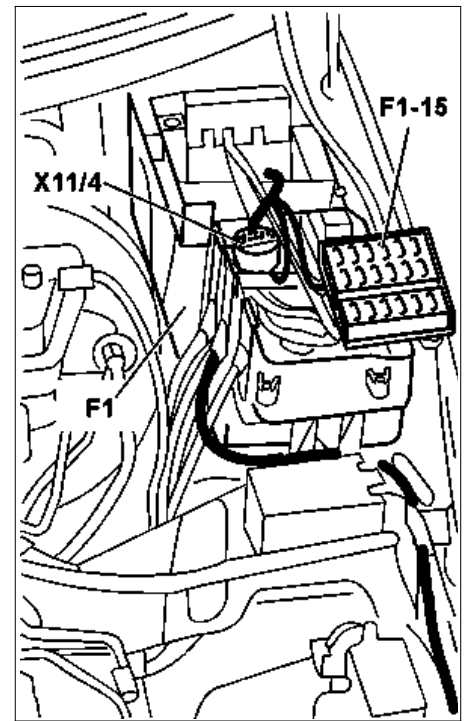

P82.10-0479-17

- 14 Route 6-pin sockets at left wheelhousing to the left headlamp opening and attach.

E1 Left headlamp unit (socket)

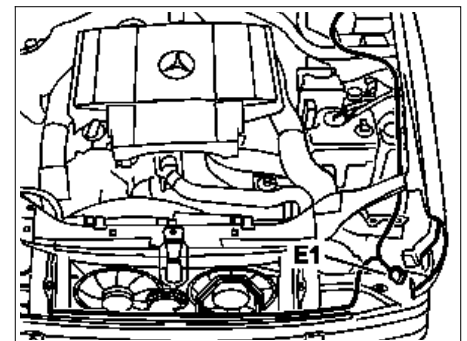

P82.10-0480-13

- 15 Route other branches of the 6-pin sockets in front of the radiator to the right headlamp opening and attach with cable straps (arrows).

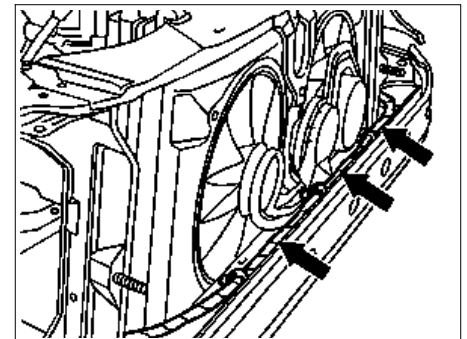

P82.10-0481-13

- 16 Route longest branch with 6-pin socket from the right headlamp opening along the main wiring harness to the right of the front axle and attach.

A52 Headlamp range adjustment front axle sensor (socket)

E2 Right headlamp unit (socket)

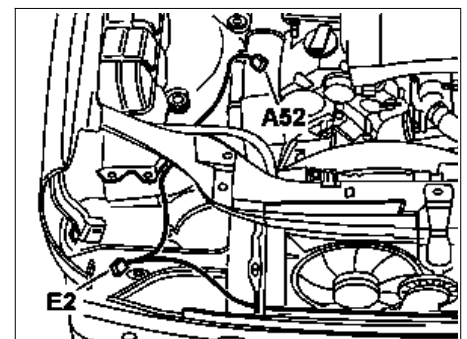

- 17 Route extended brown cable, green/black cable and 6-pin socket below the plate (F) of the rear seat bench behind the rear fuse box (F4) to the right cable duct and attach with omega clips (E).

**i** Rework plate (F) so that wiring harness does not chafe or is squeezed.

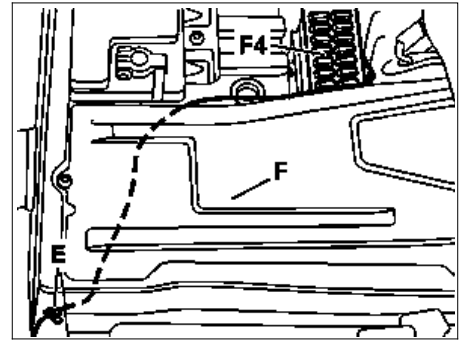

P82.10-0483-13

- 18 Route extended brown cable and green/black cable in cable duct to the cable connector (X62/21).

- 19 Connect green/black cable to the cable connector (X62/21).

z *Cable connector*

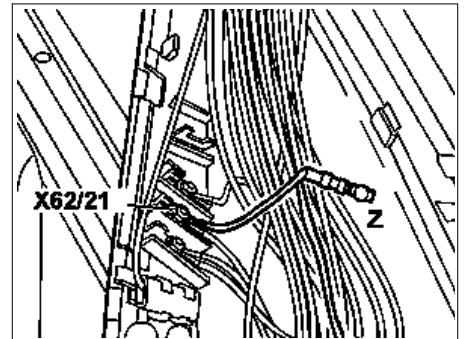

P82.10-0484-13

- 20 Connect extended brown cable at the ground point (W15/1).

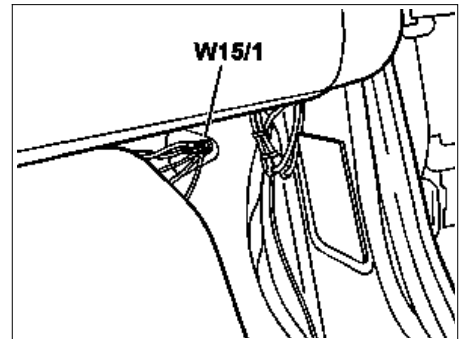

P82.10-0485-13

- 21 Detach purple vacuum line at vacuum distributor (arrow) ahead of the control module box (F23/1) (is no longer required).

- 22 Install xenon headlamps and connect wiring harness.

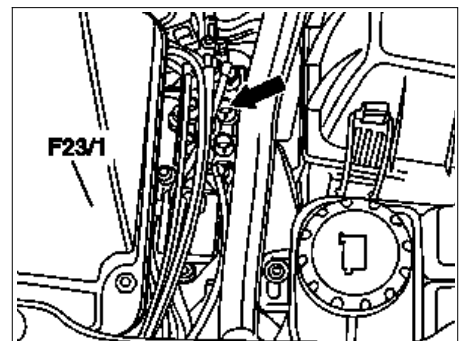

P82.10-0487-13

### Models without stationary heater/ heater booster

23.1 Make hole (15) in area of fuel pump assembly at spacing G with  $\varnothing$  28 mm.

### **⚠ Danger!**

**Do not damage cables of rear fuse box.**

### Models with stationary heater/ heater booster

23.2 Use grommet of fuel metering pump.

24 Route 6-pin socket to rear axle sensor behind rear fuse box to the outside.

G 40 mm

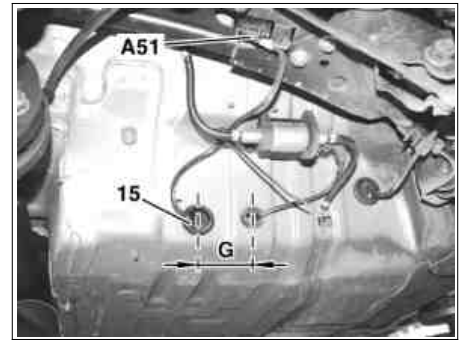

P82.10-2526-01

25 Make holes for attaching headlamp range adjustment control module (N71) with a drift according to spacings C and D in the area below the left rear seat.

**i** Use headlamp range adjustment control module (N71) as a template.

26 Attach headlamp range adjustment control module (N71) with bolts (3) and washers (4).

27 Connect socket to the headlamp range adjustment control module (N71).

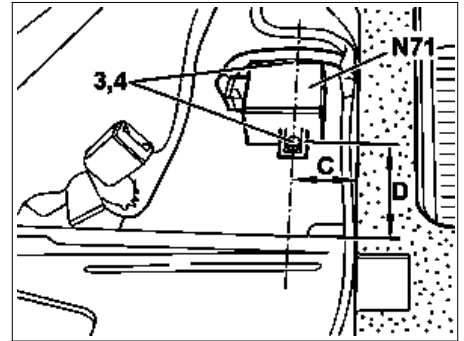

P82.10-0475-13

### Location below left rear seat

3 Bolt BZ4.8X13

C Spacing 80 mm

D Spacing 230 mm

28 Insert yellow/black cable into receptacle 10 of the 21-pin socket "A" of the light module (N7-1).





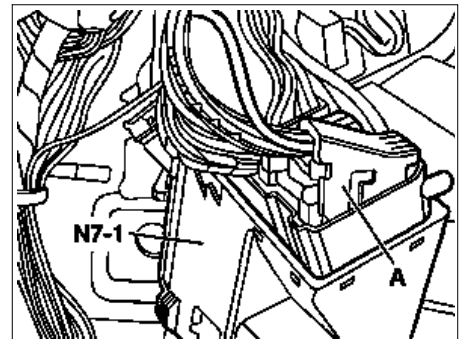





29 Install new trim ring at light module (N7-1).

30 Tie back headlamp range adjuster (do not disconnect).



P82.10-0541-13

**MODEL 210 up to 30.6.99**

	<b>Remove</b>		
1  <b>AR</b>	Disconnect ground lead from battery		AR54.10-P-0003A
2  <b>AR</b>	Remove radio		AR82.60-P-7502EA
3  <b>AR</b>	Remove cover above heater or air conditioning control panel		AR68.20-P-2350F
4	Unclip cockpit switch group or front heated seats control module		
5	Remove cover in left footwell		
6  <b>AR</b>	Remove front bumper		AR88.20-P-2000F
7  <b>AR</b>	Remove headlamp covers on left and right		AR82.10-P-4730EB
8	Remove washer fluid reservoir		
9	Empty washing water reservoir		
10	Open cover on fuse box		
11  <b>AR</b>	Remove relay cover		AR54.15-P-1255EB
12	Remove relay holder		
13	Remove cycle module		
	<b>Install</b>		
14	Retrofit headlamp cleaning system wiring harness		AN82.15-P-0001-01A
15	Retrofit switch		AN82.15-P-0001-02A
16	Retrofit washer fluid reservoir and washer fluid hose		AN82.15-P-0001-03A
17	Retrofit telescopic nozzles		AN82.15-P-0001-04A
18	Install in the reverse order	 Steps 13 - 1.	
19	Carry out function check		
20	To be subsequently entered where package code or designation of corresponding special equipment on vehicle data card/FDOK modified	 Code 600	

**Parts ordering notes**

Part no.	Designation	Quantity
Design group 99	Telescopic nozzle set (It is necessary to paint the headlamp covers included in the telescopic nozzle set to match the color of the car before installation)	1



- 1 Remove socket of headlamp cleaning system switch (S4/1) and socket of cycle module (N65) from the wiring harness.

M5/2 Headlamp washer pump

W16/3 Output ground, left wheelhousing

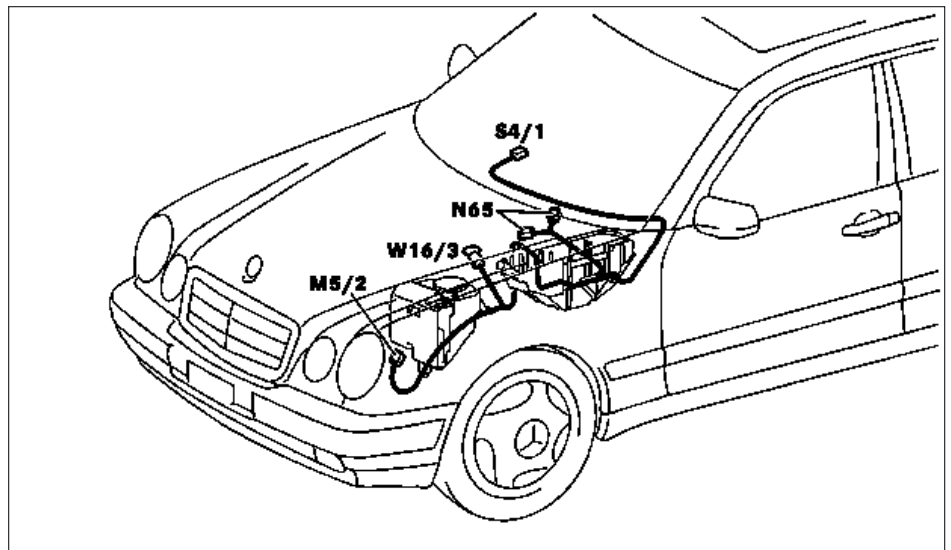

P82.15-0212-05

- 2 Draw wiring harness through one of the rubber grommets (arrows) in the fuse box.
- 3 Tie back non-insulated cable (br/bl) in fuse box.
- 4 Insert bush (4 mm) into 1-pin socket of cycle module (N65).
- 5 Insert bush (2.5 mm) into existing 5-pin socket (1) of tail lamp wiring harness into receptacle 4.
- 6 Route wiring harness along the existing wiring harnesses in the engine compartment.
- 7 Attach cable (br) to ground point (W16/3).
- 8 Route wiring harness through the fuse box into the interior.

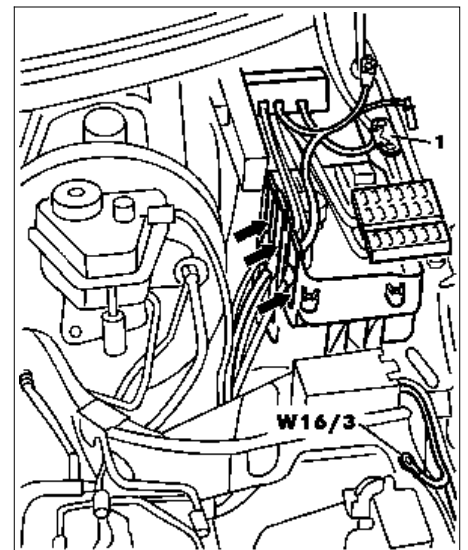

P82.15-0213-02

- 9 Route wiring harness along the cross pipe (2) as far as the cockpit switch group and attach with 3 cable straps (3).
- 10 Insert wiring harness (br/bl) into 3-pin socket of headlamp cleaning system switch into receptacle 6.

**i** Bend up detent lugs at the contact spring before inserting into the socket to ensure that it correctly engages in the socket.

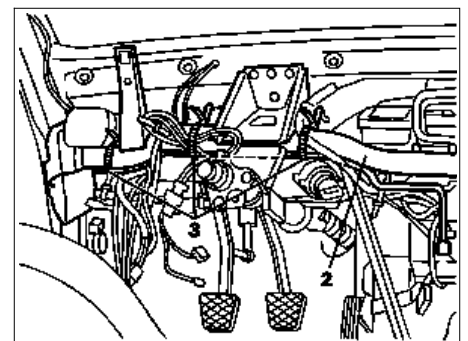

P82.15-0214-01

- M5/2 Headlamp washer pump
- N65 Cycle module
- S4/1 Headlamp cleaning system switch
- W16/3 Output ground, left wheelhousing

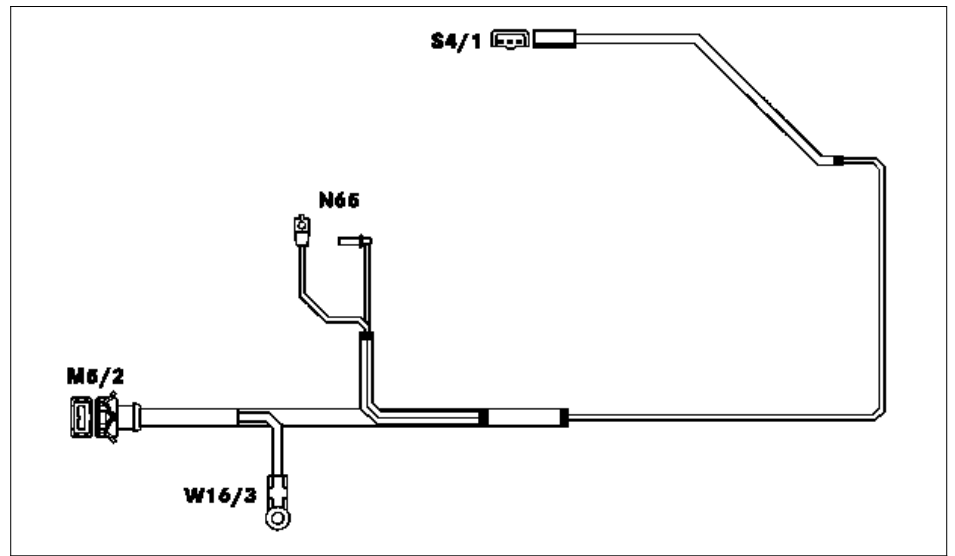

P82.15-0221-05

MODEL 208, 210

Illustrated on model 210

- 1 Cover  
 3 Screw  
 4 Electrical connections  
 5 Screw  
 N7-1 Light module

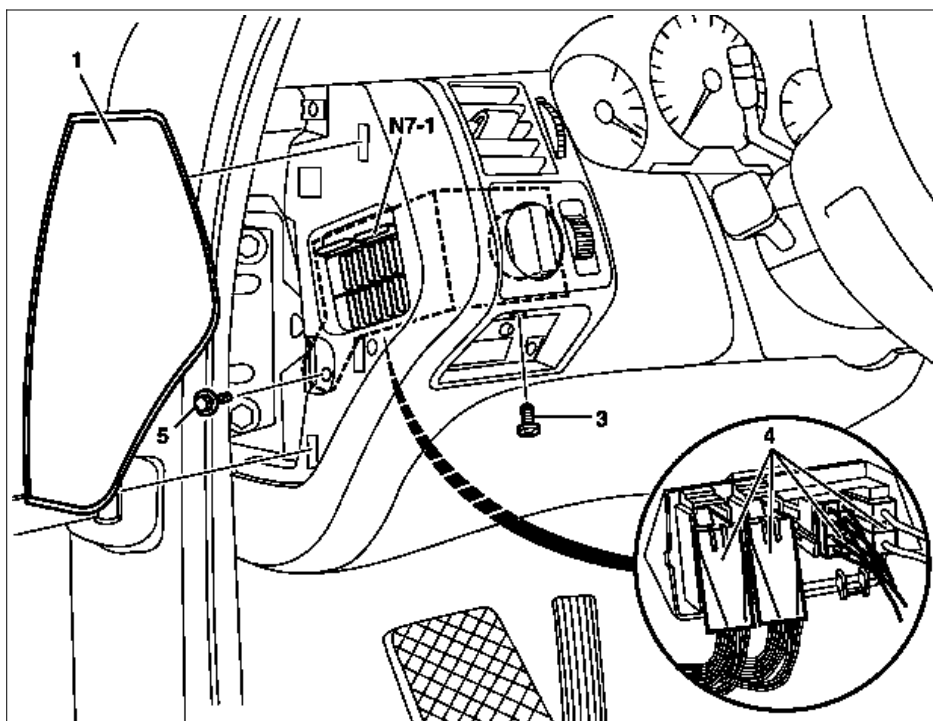

P54.25-0214-06

☒ ☒	Removal, installation		
1	Disconnect ground cable from battery	ⓘ Insulate terminal on ground cable to prevent unintentional contact between disconnected ground cable and ground W10.	AR54.10-P-0003A
2	Unhook control cable on release lever for parking brake and remove release lever guide	ⓘ Installation: Clip release lever guide into mount on light module housing opposite direction of forward motion	
3.1	Remove bottom section of instrument panel (driver's side)	Model 208	AR68.10-P-1505K
3.2	Remove cover below instrument panel (driver's side)	Model 210	AR68.10-P-1500F
4	Unhook and disconnect electrical connections (4) on rear of light module (N7-1)	ⓘ Installation: Complete electrical connections only after installing light module	
5	Unscrew screws (3, 5)	ⓘ Installation: First screw in screw (3) in area of parking brake release lever. While screwing in support light module from below with hand and align on hole for second screw	
6	Remove light module (N7/1) from instrument panel		
☞ GF	Assignments and lead connections for fuse blocks:	Model 208 Model 210	GF54.15-P-1255EF GF54.15-P-1255EA
7	Reinstall in opposite order		