

- Picture -

Mode : MDmode

FIN/MD : 124029

Catalog no. : 44Q

VIN :

Major assembly :

Salesdesignation: 280 E/E 280

Major assembly MD :

Assortment class : Car

Group : 68 - COVERING

Market : Europe

Subgroup : 270 - HOUSING WITH TRAY,ASHTRAY,AND TOP COVERING

Picture number : B68270000141.950517

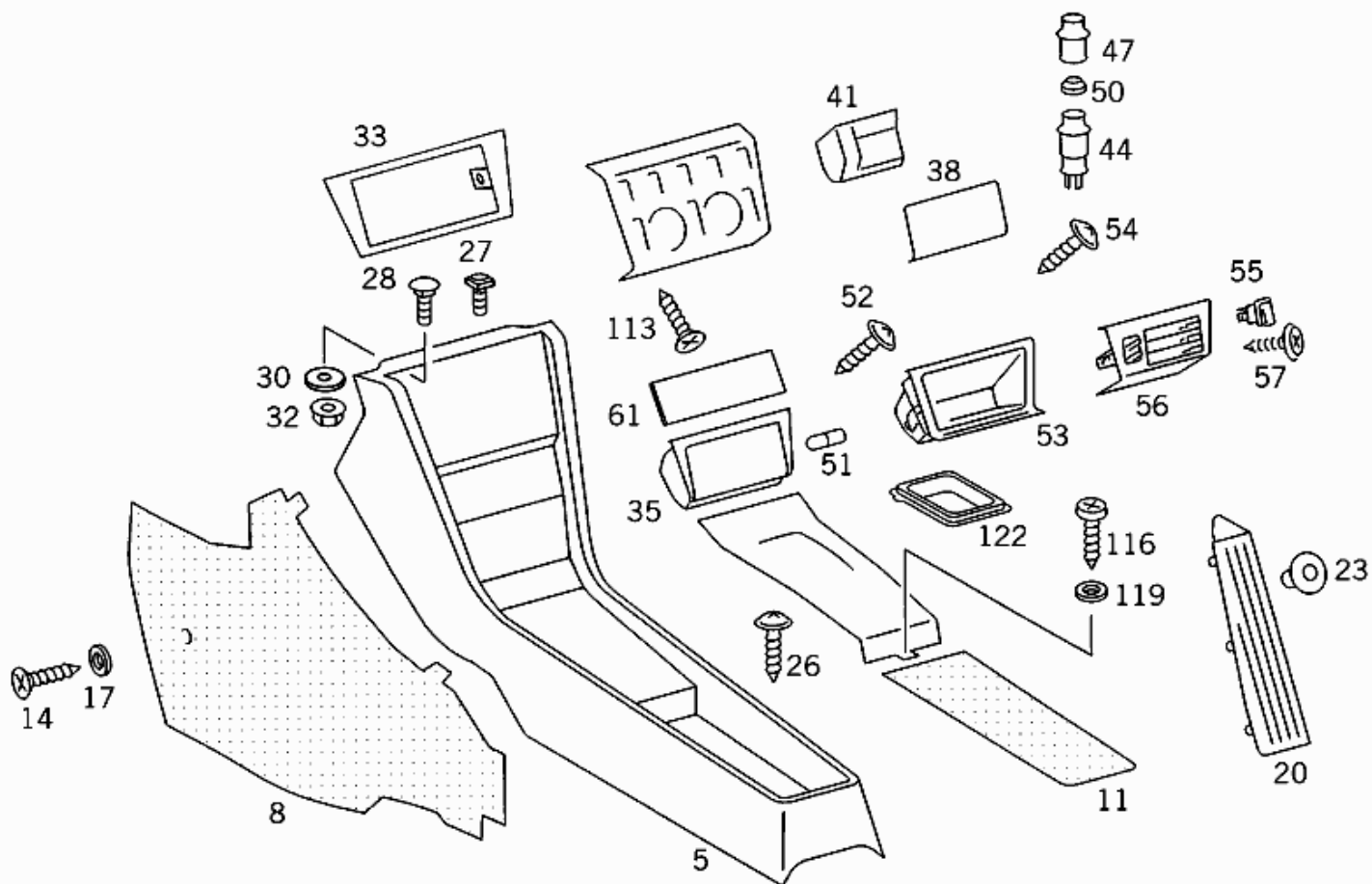

- Picture -

Mode : MDmode

FIN/MD : 124029

Catalog no. : 44Q

VIN :

Major assembly :

Salesdesignation: 280 E / E 280

Major assembly MD :

Assortment class : Car

Group : 68 - COVERING

Market : Europe

Subgroup : 270 - HOUSING WITH TRAY,ASHTRAY,AND TOP COVERING

Picture number : B68270000063.080409

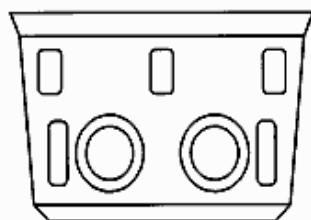

62

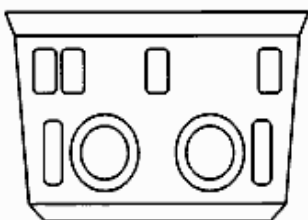

65

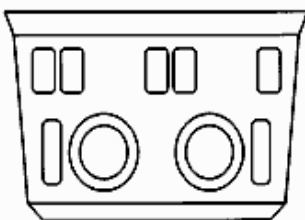

68

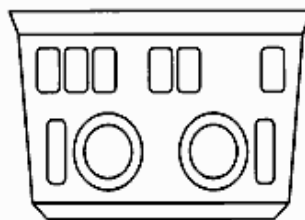

71

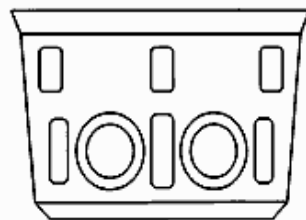

74

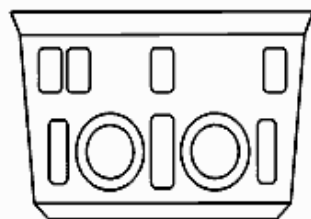

77

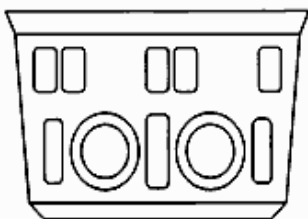

80

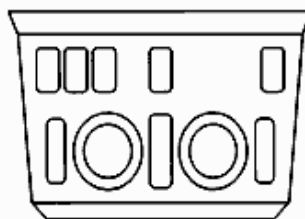

82

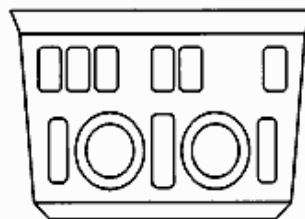

83

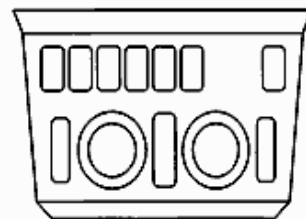

86

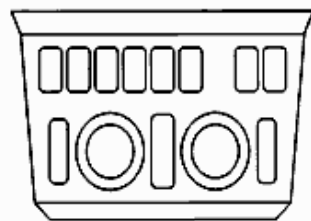

89

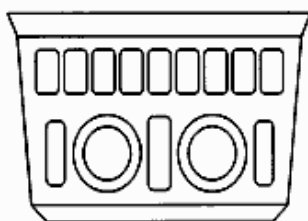

92

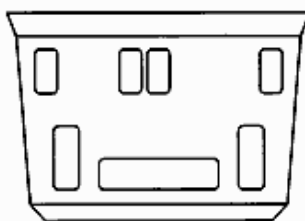

95

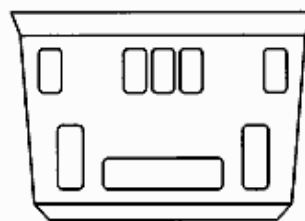

98

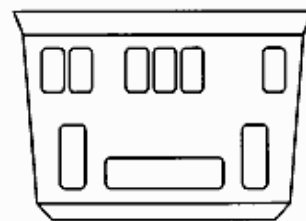

101

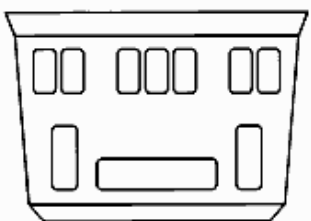

104

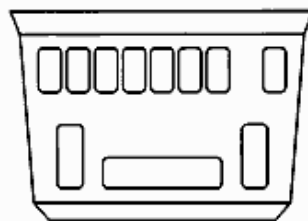

107

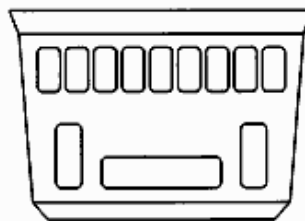



110

- Parts list -

Mode :	MD mode	FIN/MD :	124029
Catalog no. :	44Q	VIN :	
Major assembly :		Sales designation :	280 E / E 280
Major assembly MD :		Assortment class :	Car
Group :	68 - COVERING	Market :	Europe
Subgroup :	270 - HOUSING WITH TRAY,ASHTRAY,AND TOP COVERING		

Item no.	Part number	Designation/description	Quantity	Version
5	A 124 680 08 50	<b>PANELLING</b> TUNNEL COVERING WITH TRAY [831, 902] Color footnote	001	L
5	A 124 680 08 50	<b>PANELLING</b> TUNNEL COVERING WITH TRAY [840, 904] Color footnote	001	L
5	A 124 680 09 50	<b>PANELLING</b> TUNNEL COVERING WITH TRAY [831, 902] Color footnote	001	R
5	A 124 680 09 50	<b>PANELLING</b> TUNNEL COVERING WITH TRAY [840, 904] Color footnote	001	R
8	A 124 680 01 68	<b>LINING</b> HOUSING;BOTTOM LEFT VELOURS [831, 903] Color footnote	001	L
8	A 124 680 01 68	<b>LINING</b> HOUSING;BOTTOM LEFT VELOURS [840, 909] Color footnote	001	L
8	A 124 680 07 68	<b>LINING</b> HOUSING;BOTTOM LEFT VELOURS [831, 903] Color footnote	001	R
8	A 124 680 07 68	<b>LINING</b> HOUSING;BOTTOM LEFT VELOURS [840, 909] Color footnote	001	R
8	A 124 680 09 68	<b>LINING</b> HOUSING;BOTTOM RIGHT VELOURS [831, 903] Color footnote	001	L
8	A 124 680 09 68	<b>LINING</b> HOUSING;BOTTOM RIGHT VELOURS [840, 909] Color footnote	001	L
8	A 124 680 20 68	<b>LINING</b> HOUSING;BOTTOM RIGHT VELOURS [831, 903] Color footnote	001	R
8	A 124 680 20 68	<b>LINING</b> HOUSING;BOTTOM RIGHT VELOURS [840, 909] Color footnote	001	R
11	A 124 683 06 51	<b>LINING</b> IN TRAY BETWEEN FRONT SEATS VELOURS [831, 903] Color footnote	001	
11	A 124 683 06 51	<b>LINING</b> IN TRAY BETWEEN FRONT SEATS VELOURS [840, 909] Color footnote	001	
14	N 007983 003274	<b>SHEET METAL SCREW</b> HOUSING TO TUNNEL,FRONT LEFT AND RIGHT B 3.9X38	002	L
		<b>SHEET METAL SCREW</b>		

14	N 007983 003274	<b>SHEET METAL SCREW</b> HOUSING TO TUNNEL,FRONT LEFT B 3.9X38	001	R
14	N 007983 004282	<b>SHEET METAL SCREW</b> <b>Replaced by:</b> N 000000 000506	-	R
14	N 000000 000506	<b>SHEET METAL SCREW</b> HOUSING TO TUNNEL,FRONT RIGHT B 4,2X25	001	R
17	A 301 990 00 42	<b>WASHER</b> HOUSING TO TUNNEL,FRONT RIGHT	001	R
20	A 124 976 00 60	<b>FOOTREST</b>  [831, 907] Color footnote	001	R
20	A 124 976 00 60	<b>FOOTREST</b>  [840, 914] Color footnote	001	R
23	A 001 988 14 81	<b>FASTENER BUTTON</b> FOOTREST TO FIRE WALL	001	R
26	N 914127 004213	<b>SHEET METAL SCREW</b> <b>Replaced by:</b> N 000000 000523	-	R
26	N 000000 000523	<b>SHEET METAL SCREW</b>	003	R
26	N 914127 004205	<b>SHEET METAL SCREW</b> HOUSING TO TUNNEL,REAR B 4,2X16	001	
27	A 000 990 52 33	<b>SCREW</b> HOUSING TO INSTRUMENT PANEL	001	
28	N 000603 006057	<b>SCREW</b> HOUSING TO INSTRUMENT PANEL	001	
30	N 009021 006103	<b>WASHER</b> <b>Replaced by:</b> N 009021 006208	-	
30	N 009021 006208	<b>WASHER</b> HOUSING TO INSTRUMENT PANEL	001	
32	N 913011 006000	<b>NUT</b> HOUSING TO INSTRUMENT PANEL	002	
33	A 124 680 28 36	<b>COVERING</b> AUTOMOBILE TELEPHONE ZEBRANO	001	
33	A 124 683 65 08	<b>COVERING</b> AUTOMOBILE TELEPHONE Code: 731	001	
35	A 124 810 10 30	<b>ASHTRAY</b> FRONT ZEBRANO	001	
35	A 124 810 15 30	<b>ASHTRAY</b> FRONT ASHTRAY,BURLED WALNUT Code: 731	001	
38	A 124 810 02 07	<b>COVERING</b> ASHTRAY ZEBRANO	001	
38	A 124 810 03 07	<b>COVERING</b> ASHTRAY Code: 731	001	
41	A 124 810 02 28	<b>INSERT</b>	001	
44	A 000 820 10 53	<b>CIGAR LIGHTER</b> WITH CIGAR LIGHTER SLEEVE	001	
47	A 000 825 09 51	<b>ELEMENT</b>	001	
50	A 000 825 02 52	<b>INCANDESCENT SPIRAL</b>	001	
51	N 072601 012110	<b>BULB</b> FRONT ASHTRAY J-12V 2W	001	
52	N 914138 004207	<b>SCREW</b> <b>Replaced by:</b> A 001 984 64 29	-	
52	A 001 984 64 29	<b>SCREW</b> ASHTRAY TO HOUSING B 4.8X16	002	
53	A 124 846 00 69	<b>PIGEONHOLE</b> LESS ASHTRAY Code: 304	001	
54	N 914136 004202	<b>SCREW</b> LESS ASHTRAY Code: 304	001	
55	A 202 820 00 51	<b>FITTING MOLD</b> (PLUG SOCKET) Code: 304	001	
56	A 124 840 32 62	<b>CONTAINER</b> CASSETTE Code: 304+331  [402] NO LONGER AVAILABLE	001	

57	N 914138 004207	<b>SCREW</b> Replaced by:A 001 984 64 29 Code: 304+331	-
57	A 001 984 64 29	<b>SCREW</b> CASSETTE Code: 304+331	001
61	A 140 683 01 10	<b>COVER</b> APERTURE FOR RADIO	001
		<b>TOP COVERING IN HOUSING</b>	
62	A 124 680 33 39	<b>ORNAMENTAL COVER</b> ZEBRANO	001
62	A 124 680 76 18	<b>COVERING</b> SPECIAL VERSION: BURLED WALNUT ROOT, CODE 731	001
65	A 124 680 34 39	<b>ORNAMENTAL COVER</b> HEADREST ADJUSTMENT IN THE REAR OR TRUMPET HORN ZEBRANO	001
65	A 124 680 34 39	<b>ORNAMENTAL COVER</b> ELECTRIC ROLLER BLIND ON REAR WINDOW PANE ZEBRANO	001
65	A 124 680 77 18	<b>COVERING</b> HEADREST ADJUSTMENT IN THE REAR OR TRUMPET HORN Code: 731	001
65	A 124 680 77 18	<b>COVERING</b> ELECTRIC ROLLER BLIND ON REAR WINDOW PANE	001
68	A 124 680 35 39	<b>ORNAMENTAL COVER</b> HEADREST ADJUSTMENT IN THE REAR AND TRUMPET HORN ZEBRANO	001
68	A 124 680 35 39	<b>ORNAMENTAL COVER</b> ELECTRIC ROLLER BLIND ON REAR WINDOW PANE,AND TRUMPET HORN ZEBRANO	001
68	A 124 680 35 39	<b>ORNAMENTAL COVER</b> REAR HEADREST ADJUSTMENT AND ELECTRIC ROLLER BLIND ON REAR PANE ZEBRANO	001
68	A 124 680 78 18	<b>COVERING</b> HEADREST ADJUSTMENT IN THE REAR AND TRUMPET HORN Code: 731	001
68	A 124 680 78 18	<b>COVERING</b> ELECTRIC ROLLER BLIND ON REAR WINDOW PANE,AND TRUMPET HORN	001
68	A 124 680 78 18	<b>COVERING</b> REAR HEADREST ADJUSTMENT AND ELECTRIC ROLLER BLIND ON REAR PANE	001
71	A 124 680 58 39	<b>ORNAMENTAL COVER</b> REAR HEADREST ADJUSTMENT,ELECTRIC ROLLER BLIND & TRUMPET HORN ZEBRANO	001
71	A 124 680 93 18	<b>COVERING</b> REAR HEADREST ADJUSTMENT,ELECTRIC ROLLER BLIND & TRUMPET HORN Code: 731	001
74	A 124 680 91 89	<b>COVER</b> AIR CONDITIONER AND THREE (3) SWITCHES ZEBRANO Code: 580	001
74	A 124 683 19 08	<b>COVERING</b> AIR CONDITIONER AND THREE (3) SWITCHES Code: 731+580	001
77	A 124 680 92 89	<b>COVER</b> AIR CONDITIONER AND FOUR (4) SWITCHES ZEBRANO Code: 580	001
77	A 124 683 20 08	<b>COVERING</b> AIR CONDITIONER AND FOUR (4) SWITCHES Code: 731+580	001

80	A 124 680 93 89	<b>COVER</b> AIR CONDITIONER AND FIVE (5) SWITCHES ZEBRANO Code: 580	001
80	A 124 683 21 08	<b>COVERING</b> AIR CONDITIONER AND FIVE (5) SWITCHES Code: 731+580	001
82	A 124 683 27 08	<b>COVERING</b> AIR CONDITIONER AND FIVE (5) SWITCHES Code: 731	001
83	A 124 680 34 17	<b>COVERING</b> AIR CONDITIONER AND SIX (6) SWITCHES ZEBRANO Code: 580	001
83	A 124 683 28 08	<b>COVERING</b> AIR CONDITIONER AND SIX (6) SWITCHES Code: 731+580	001
86	A 124 680 66 39	<b>ORNAMENTAL COVER</b> AIR CONDITIONER AND SEVEN (7) SWITCHES ZEBRANO Code: 580	001
86	A 124 683 61 08	<b>COVERING</b> AIR CONDITIONER AND SEVEN (7) SWITCHES Code: 731+580	001
89	A 124 680 70 39	<b>ORNAMENTAL COVER</b> AIR CONDITIONER AND EIGHT (8) SWITCHES ZEBRANO Code: 580	001
89	A 124 683 63 08	<b>COVERING</b> AIR CONDITIONER AND EIGHT (8) SWITCHES Code: 731+580	001
92	A 124 680 71 39	<b>ORNAMENTAL COVER</b> AIR CONDITIONER AND NINE (9) SWITCHES ZEBRANO Code: 580	001
95	A 124 680 49 39	<b>ORNAMENTAL COVER</b> AUTOMATIC AIR CONDITIONER AND FOUR (4) SWITCHES ZEBRANO Code: 581	001
95	A 124 680 84 18	<b>COVERING</b> AUTOMATIC AIR CONDITIONER AND FOUR (4) SWITCHES Code: 731+581	001
98	A 124 680 52 39	<b>ORNAMENTAL COVER</b> AUTOMATIC AIR CONDITIONER AND FIVE (5) SWITCHES ZEBRANO Code: 581	001
98	A 124 680 87 18	<b>COVERING</b> AUTOMATIC AIR CONDITIONER AND FIVE (5) SWITCHES Code: 731+581	001
101	A 124 680 51 39	<b>ORNAMENTAL COVER</b> AUTOMATIC AIR CONDITIONER AND SIX (6) SWITCHES ZEBRANO Code: 581	001
101	A 124 680 86 18	<b>COVERING</b> AUTOMATIC AIR CONDITIONER AND SIX (6) SWITCHES Code: 731+581	001
104	A 124 680 74 39	<b>ORNAMENTAL COVER</b> AUTOMATIC AIR CONDITIONER AND SEVEN (7) SWITCHES ZEBRANO Code: 581	001

104	A 124 683 53 08	<b>COVERING</b> AUTOMATIC AIR CONDITIONER AND SEVEN (7) SWITCHES Code: 731+581	001	
107	A 124 680 78 39	<b>ORNAMENTAL COVER</b> AUTOMATIC AIR CONDITIONER AND EIGHT (8) SWITCHES ZEBRANO Code: 581	001	
107	A 124 683 05 08	<b>COVERING</b> AUTOMATIC AIR CONDITIONER AND EIGHT (8) SWITCHES Code: 731+581	001	
110	A 124 680 79 39	<b>ORNAMENTAL COVER</b> AUTOMATIC AIR CONDITIONER AND NINE (9) SWITCHES ZEBRANO Code: 581	001	
110	A 124 683 09 08	<b>COVERING</b> AUTOMATIC AIR CONDITIONER AND NINE (9) SWITCHES Code: 731+581	001	
113	N 007982 004221	<b>SHEET METAL SCREW</b> TOP COVERING IN HOUSING B 4,2X16	002	
116	N 007971 004237	<b>SHEET METAL SCREW</b> BOTTOM COVERING IN HOUSING B 4.2X13	001	
119	N 000125 004319	<b>WASHER</b> BOTTOM COVERING IN HOUSING	001	
122	A 124 683 03 06	<b>FRAME</b>	001	M
122	A 124 683 03 06	<b>FRAME</b> SEE GROUP: 26	-	A