

ENGINE 119.97 in MODEL 124.03, 129, 140

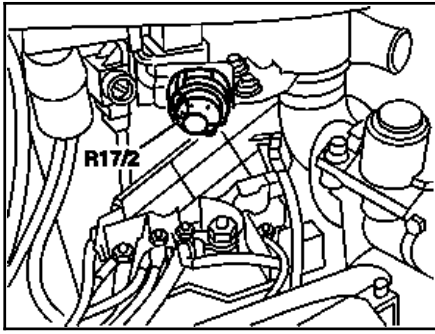

P07.41-0205-01

Model 124.03

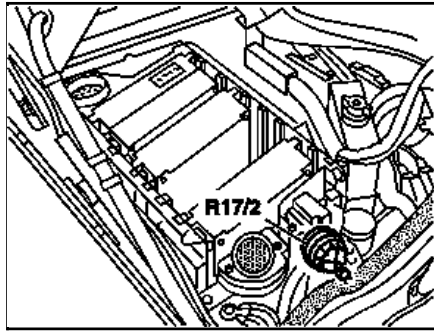

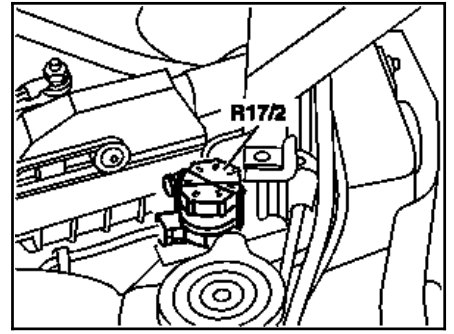

P07.41-0206-01

Model 129



P07.41-0207-01

Model 140

Fig. item, etc.	Work instructions		
R17/2  BT	LH-SFI variable reference resistor LH-SFI variable reference resistor modified	see Diagnosis Manual Engine, Volume 1, Index A. Pay attention to correction position; install new anti-tamper seal  	*124589013700 *124589246300 BT07.41-P-0001-01A

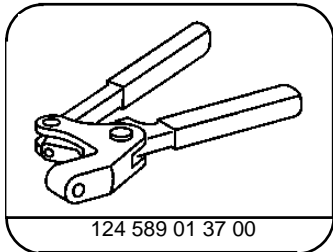

Anti-tamper seal pliers

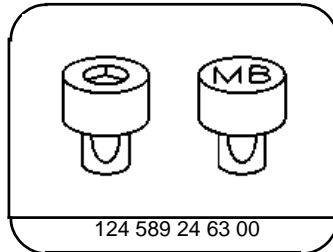

Embossing set