

### A. General information

Following body repairs, seal welding seams with material named in section **B. Sealing compounds** and protect against corrosion. This will prevent water and dirt from entering the vehicle and from penetrating welding seams.

Do not apply sealing compound on bright sheet metal. Prime welding seams first.

Also seal and paint seams and folds on sheet-metal spare parts, such as engine hood, front fender, doors, tank recess and trunk lid.

In addition to the named locations and depending on size of repairs, different sealing measures may be required, as the case may be.

### B. Sealing compounds

#### Attention!

For sealing seams, use the following sealing compounds only:

#### **MB universal sealing compound (black)**

---

Tubes at 225 g	Part no. 003 989 01 71
Cartridge at 310 ml	Part no. 002 989 98 71



For sealing rubber sleeves, cable passages as well as welding seams and overlaps.

Curing time approx. 24 hours  
 Shelf life approx. 12 months  
 at 5 to 20 °C/41–68 °F  
 Cleaner benzine

MB universal sealing compound is also suitable for glueing glass, metal, wood, fabric, cardboard and the like.

Following use, make sure to close open nozzle tip of cartridge with MB universal sealing cord to prevent early drying-out.



196-14067

### MB body sealing compounds

(can be painted over)

Cartridge at 310 ml Part no. 001 989 63 20

For weld seams, overlaps and the like. Can be painted over after drying.

Shelf life approx. 6 months  
 -cleaner benzine  
**no paint thinner or liquid containing alcohol**

An open cartridge will last only a few days and should be used up immediately, whenever possible.



197 - 25596

### MB sealing cord (5 mm dia., black)

Spool at 28 m Part no. 001 987 56 46

As shim between body parts



196-14083

## C. Sealing seams in front end area

Engine hood front and laterally, left and right

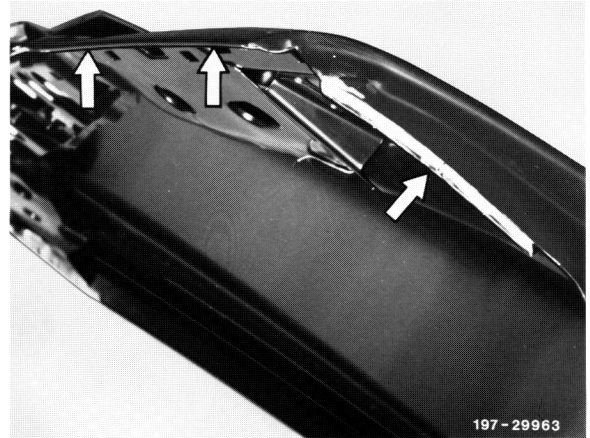

Engine hood laterally, left and right

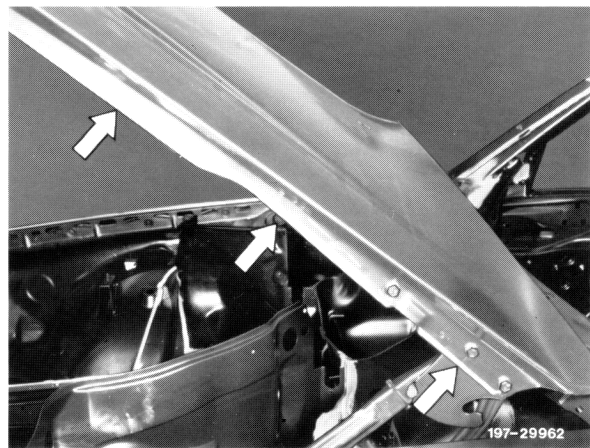

Engine hood rear, entire bead, left and right



Front fender at front, turnsignal lamp cutout

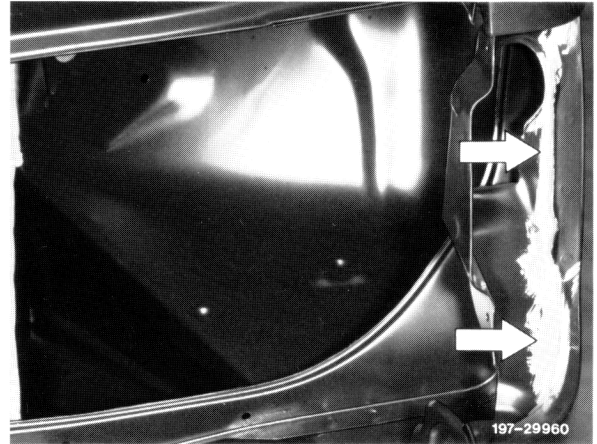

Front fender at front, turnsignal lamp cutout, underside

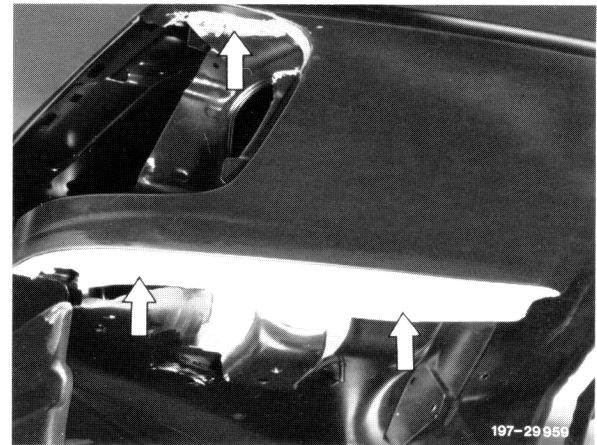

Side member, cross member front

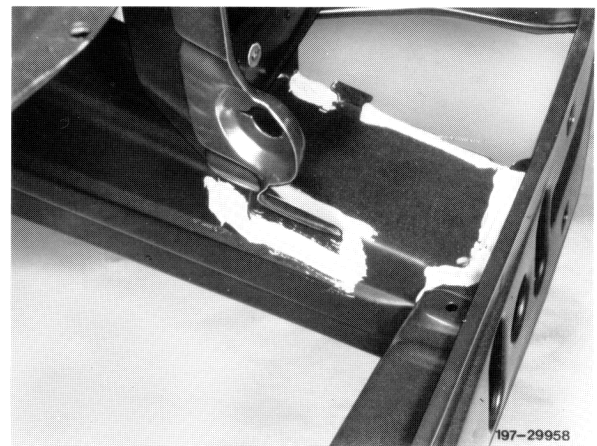

Wheelhouse, side member, cross member for front axle, bulkhead, left and right

**Note:** Leave water drain (arrow) clean.



Damper mandrel, inner connecting carrier, bulkhead, front wall, left and right



Holder for battery

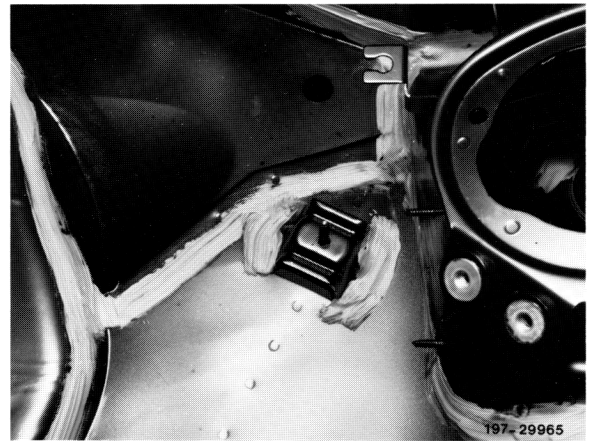

Wheelhouse, front wall, left and right, console for pedal system



Cutout for heater on front wall all-around

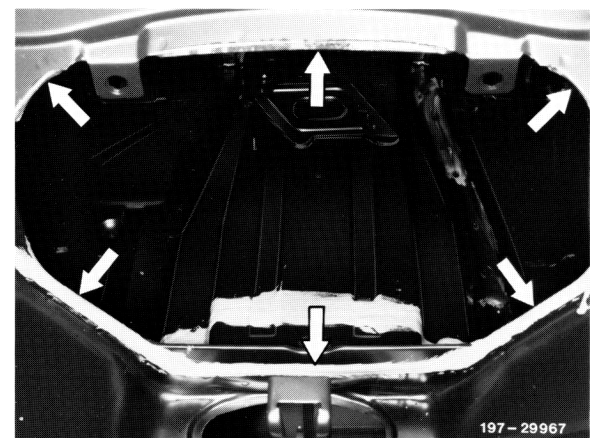

Bulkhead, inner connecting carrier, front wall

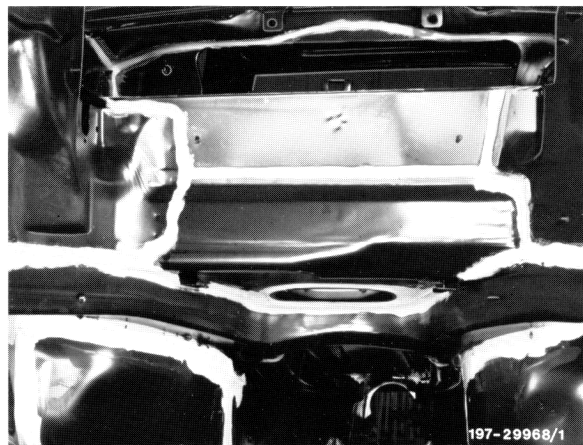

Side member, inner connecting carrier, front wall, floor left

**Note:** Leave water drains on connecting carrier inside clear.

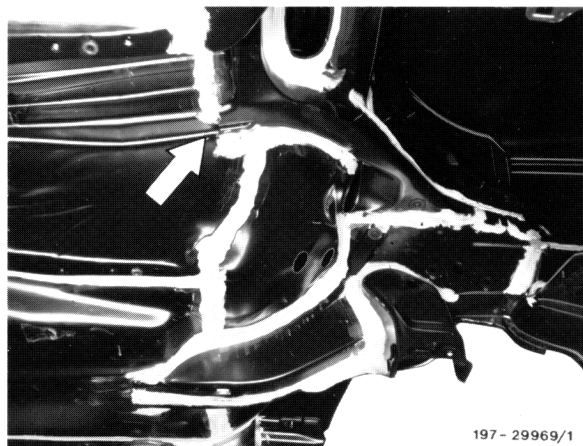

Side member, inner connecting carrier, front wall, floor right, console for intermediate steering arm

**Note:** Leave water drains on connecting carrier inside clear.

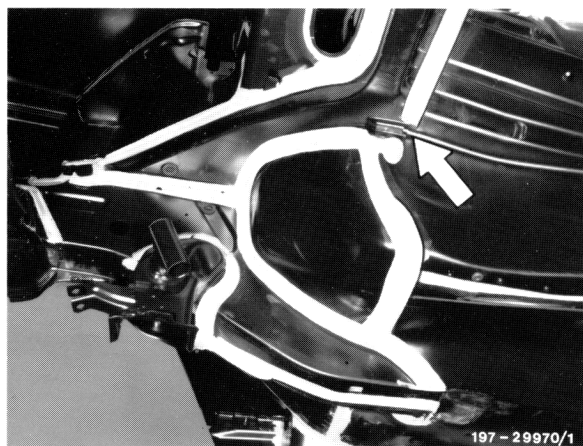

Side member front, wheelhouse, outer connecting carrier, front wall, left and right

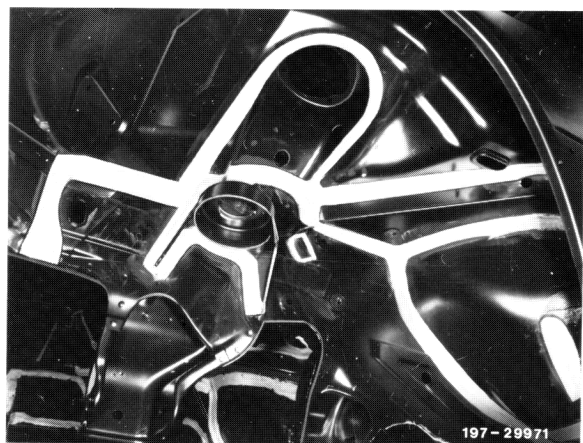

Side member front, outer connecting carrier,  
front wall, outer side member, floor left and right

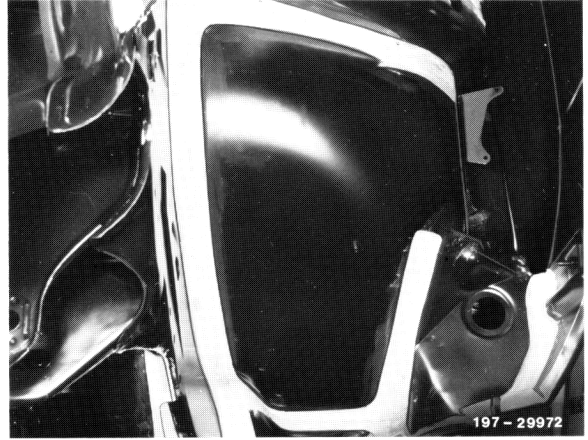

Side member front, front wall, floor left and right

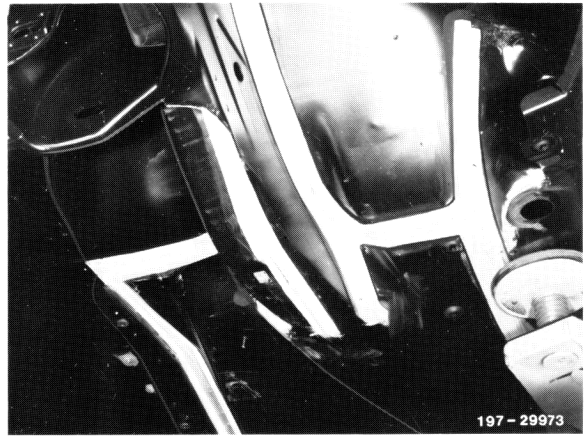

Wheelhouse, outer connecting carrier, front wall  
pillar

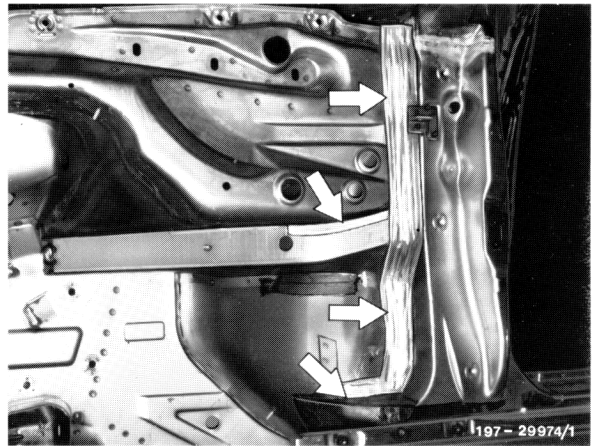

Front wall, front wall pillar, cross member under  
windshield, floor, tunnel inner connecting carrier,  
left and right



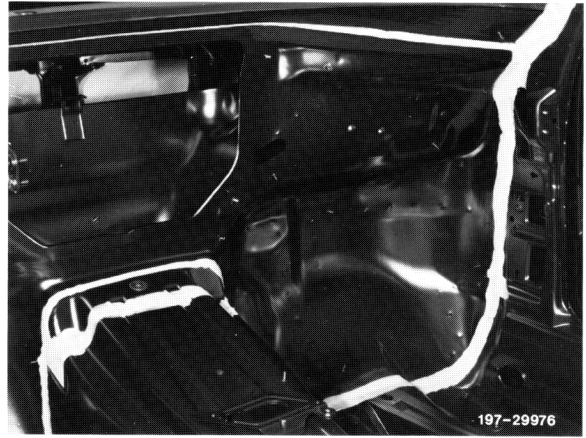

Front wall, inner connecting carrier, tunnel, floor,  
bearing for accelerator pedal

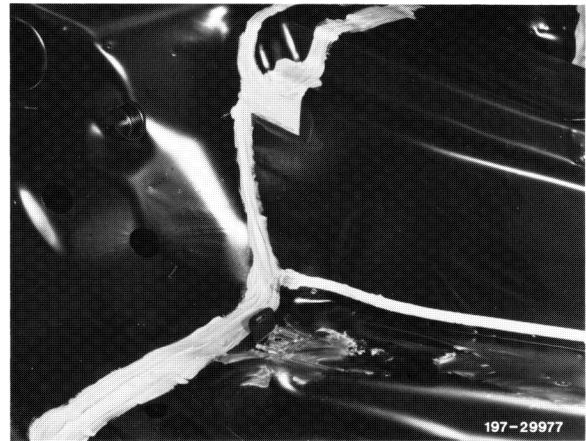

Front wall pillar, cross member under windshield

**Note:** Smooth down sealing with filler or the like.  
Driver's door front, cutout for outside mirror.





## D. Sealing seams in door area

Driver's door front, bead, holding rail, cutout for outside mirror

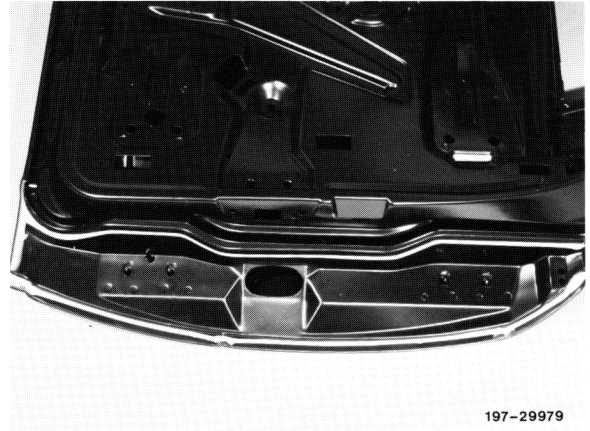

Driver's door rear, bead, holding rail

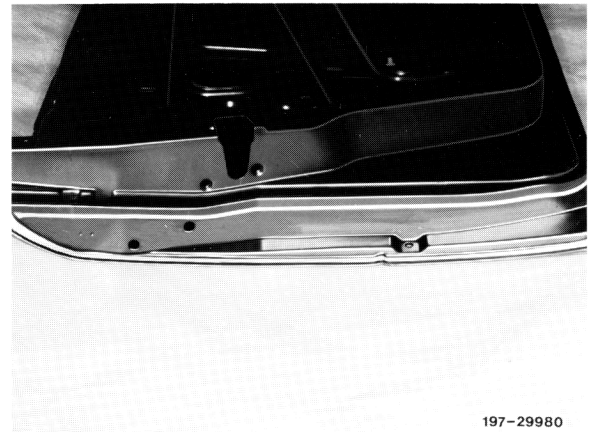

Rear door front, bead



Rear door rear, bead, holding rail



197-29982

Front wall pillar, side member, driver's door, below

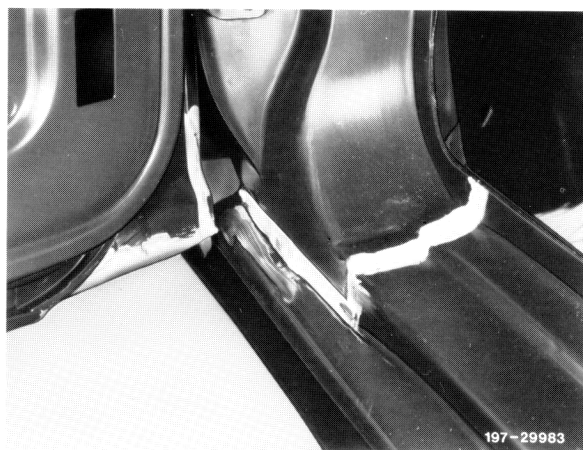

197-29983

Front wall pillar inside and top

**Note:** Smooth down sealing with filler or the like

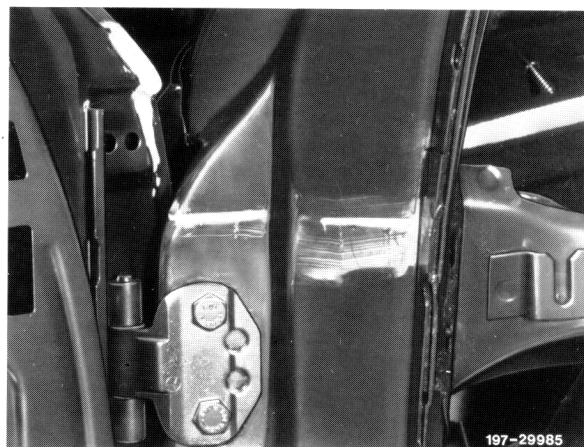

197-29985

Side member, center pillar, hinge front door top and bottom

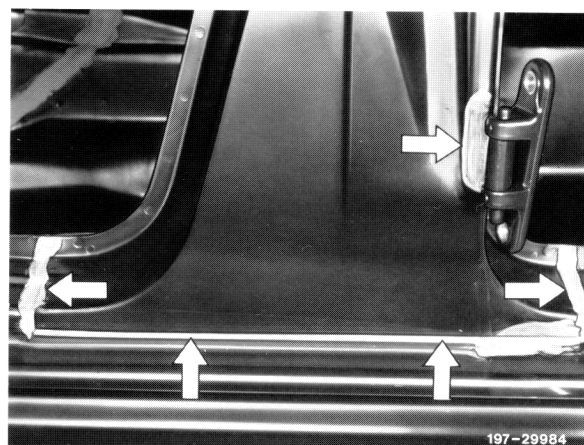

197-29984

Side member, rear fender

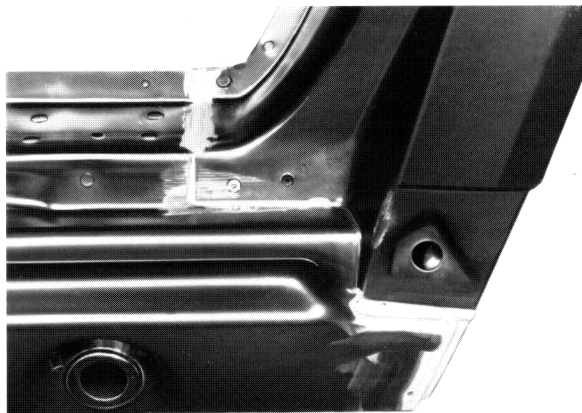

197-29987

Floor, tunnel, cross member under driver's seat, console for brake cable

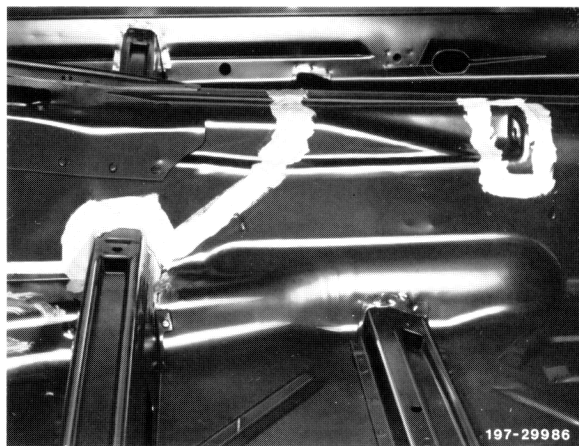

197-29986

Cross member under rear seat, floor, side member inside and rear, wheelhouse rear, bulkhead



197-29988

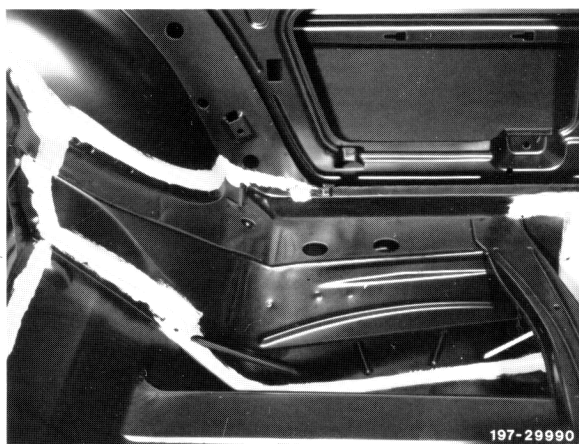

197-29990

Floor, tunnel, console for brake cable, weld nuts for shift bracket

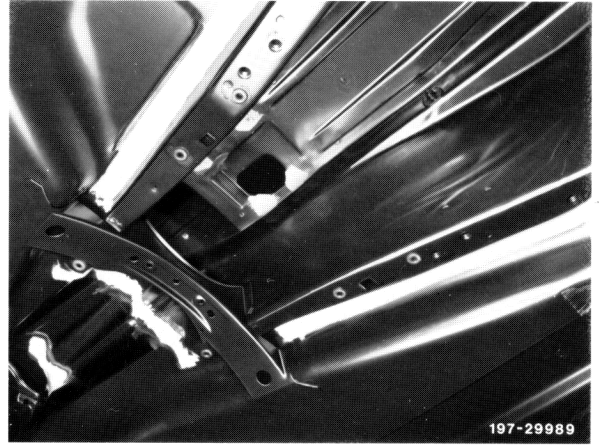

Roof panelling center, roof panelling laterally

**Note:** Apply sealing material only as thick as necessary, so that the space for the plug-in clips is not narrowed down.

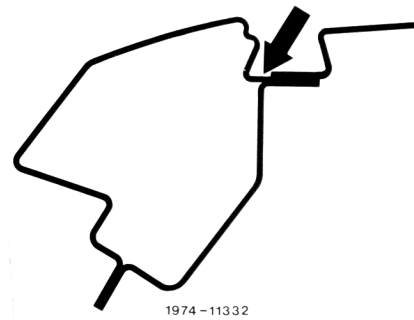

Bead between roof panelling and sun roof stiffening frame all-around

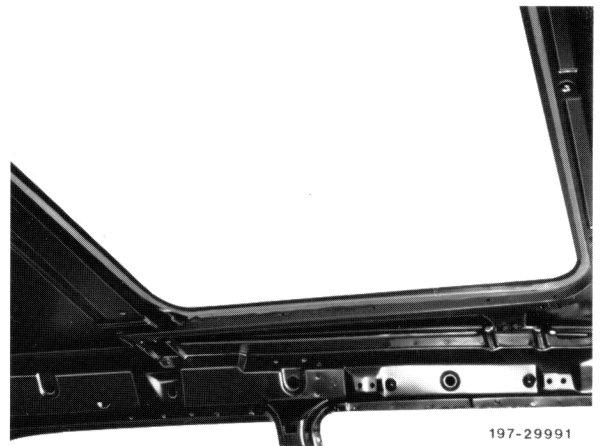

Cover for sun roof at roundings

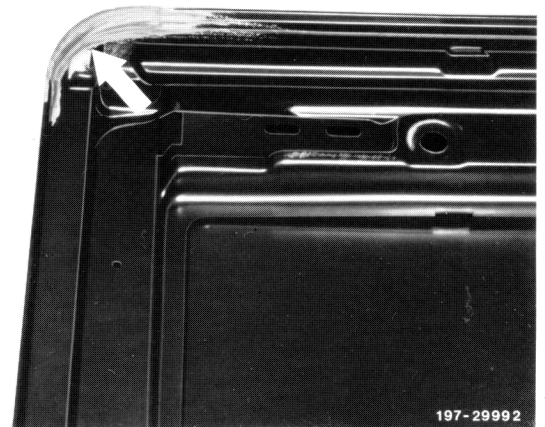

## E. Sealing seams at rear end

### Sedan

---

Bead on trunk lid all-around

**Note:** Close paint run-off bores (arrows) with plugs

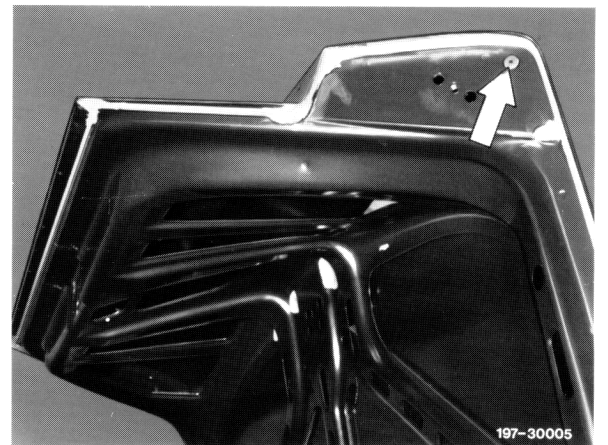
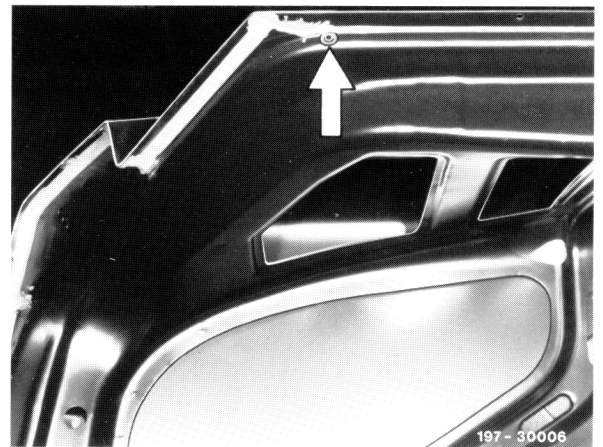

Cutout for back window top and laterally left and right

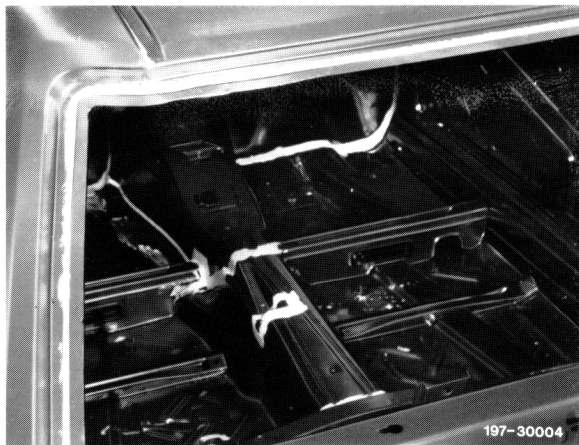

Rear fender, roof left

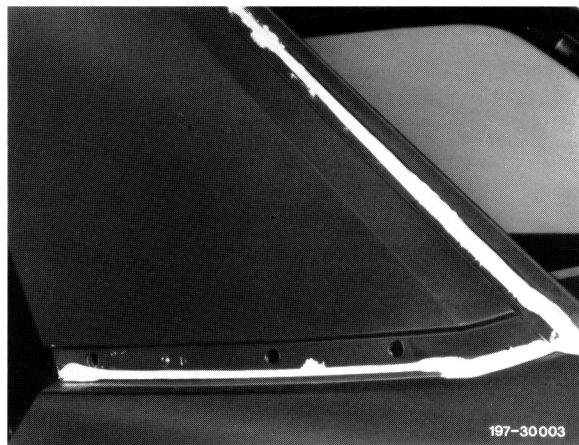

Rear fender, roof right, tank recess all-around



Wheelhouse side member, rear end floor, spare wheel recess left and right, cross member above rear axle



Wheelhouse, rear fender, spare wheel recess  
left and right

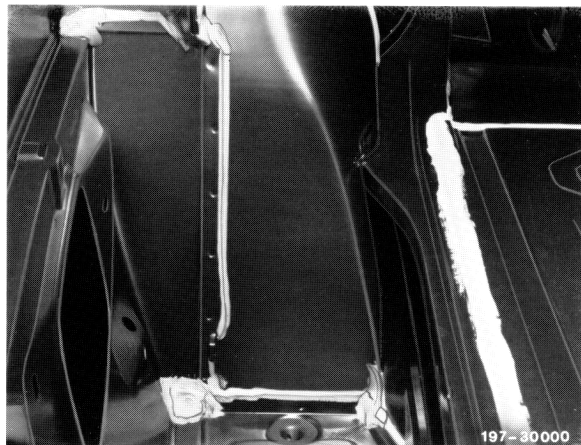

Spare wheel recess, side member, rear center  
piece left



Spare wheel recess, side member, rear center  
piece right



Rear end floor laterally, cross member, side  
member, spare wheel recess left and right

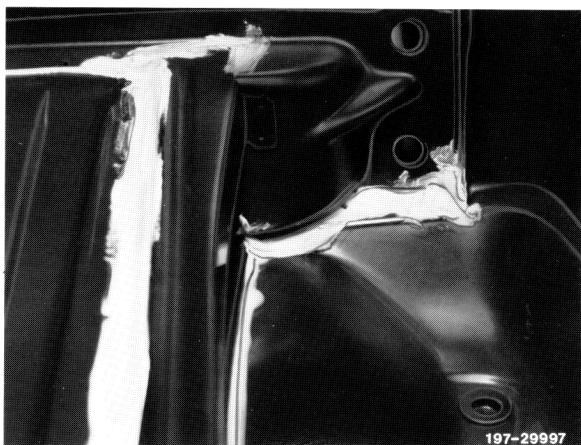

Wheelhouse, rear end floor laterally, side member, rear end floor, floor above rear axle, cross member

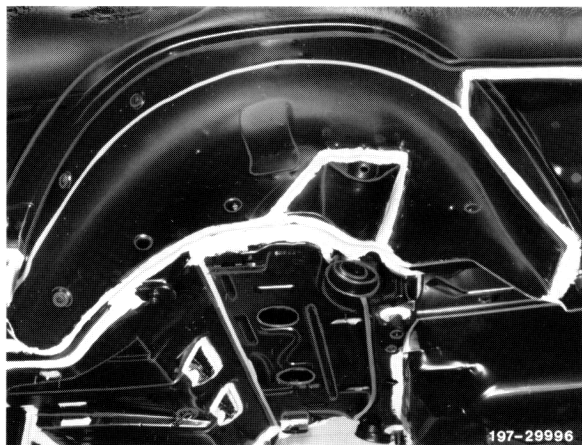

Floor, cross member under rear seat, rear end floor, floor above rear axle, plates for seat belts, consoles for rear axle, cross member above rear axle

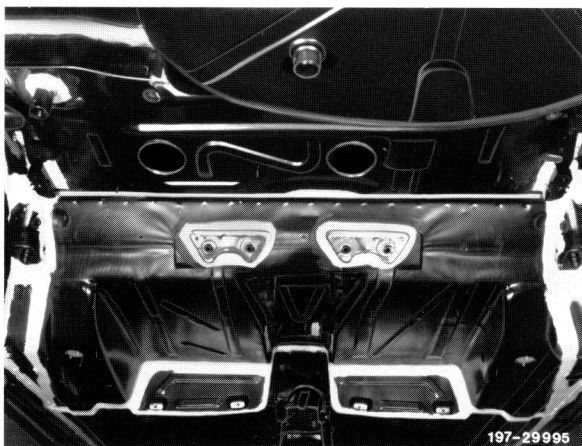

Floor above rear axle, cross member above rear axle, side member, spare wheel recess, wheelhouse, rear end floor laterally



Side member, rear floor laterally, rear fender, spare wheel recess, cross member, holder for end muffler

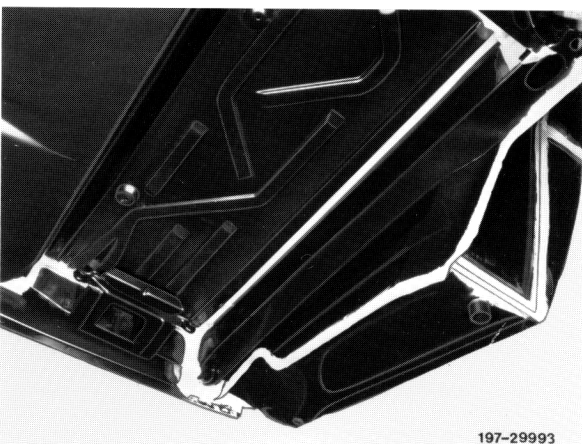



Rear center piece, cross member, side member, spare wheel recess, towing eye, paint run-off hole

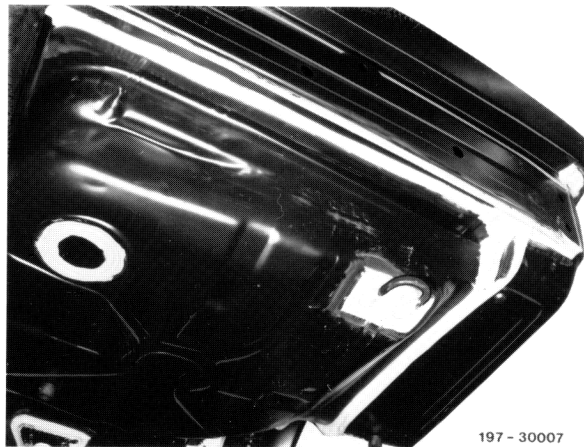

197 - 30007

### T-sedan

---

(ranges deviating from sedan)

Rebate on tailgate all-around

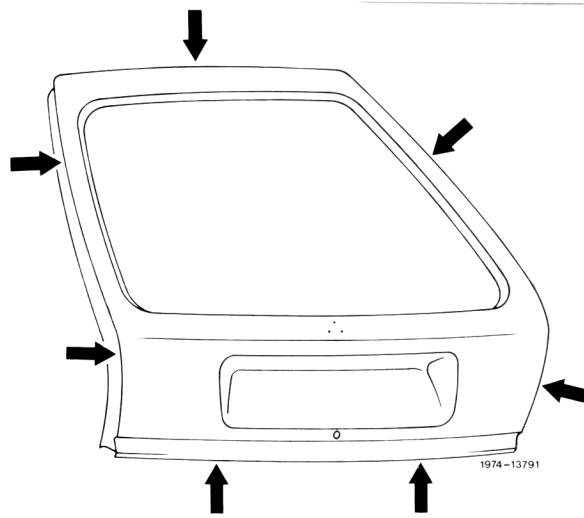

1974 - 13791

Rear floor

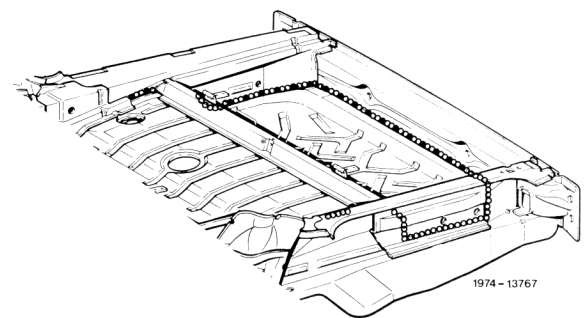

1974 - 13767

Rear fender inside and outside, tank recess all-around

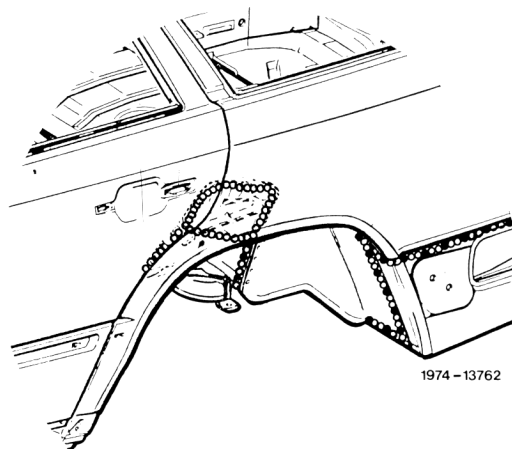

1974 - 13762

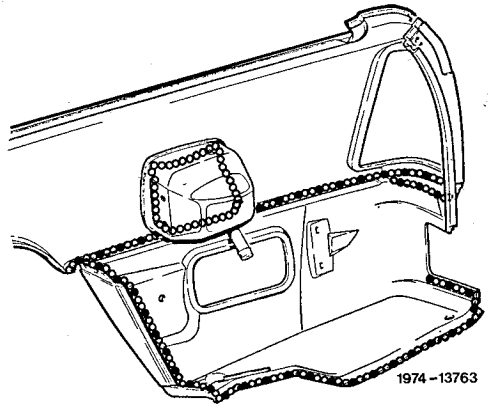

Hinge range at tailgate, cross member rear

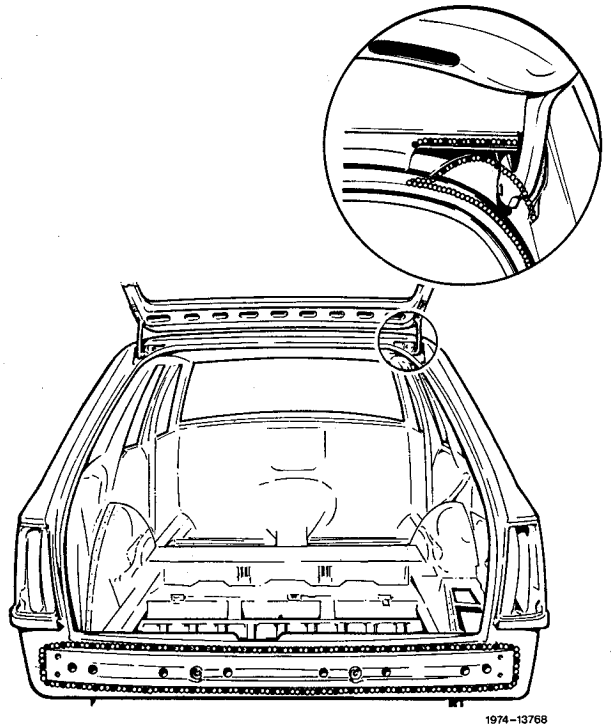

Rear floor, rear fender, cross member above rear axle, rear cross member

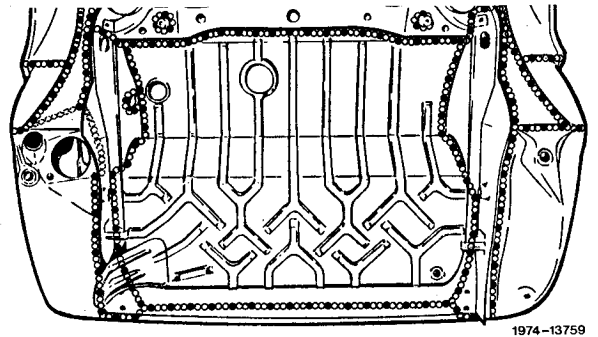

4500

**F. Convertible  
(areas deviating from sedan).**

Reinforcement plate on front wall in left and right wheelhouse.

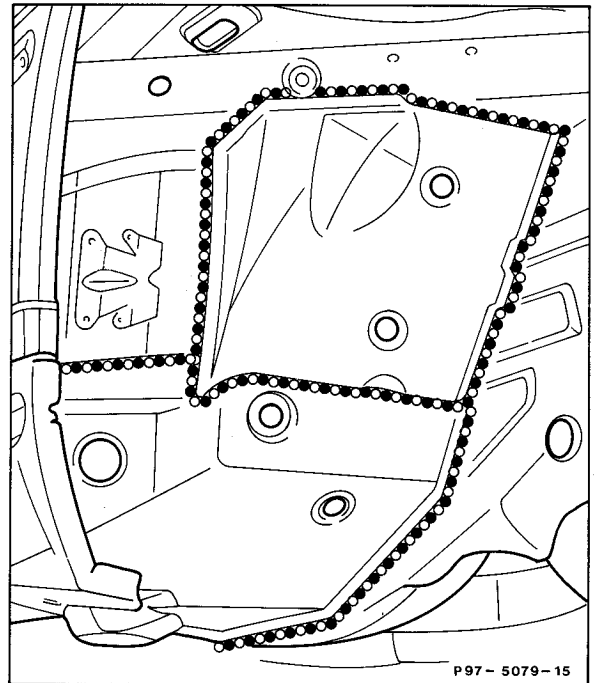

Reinforcement plate on frame side member in left and right wheelhouse.

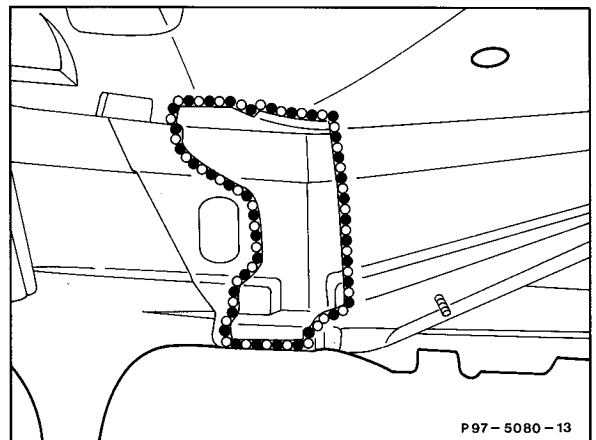

Reinforcement plate on frame side member in engine compartment on left and right.

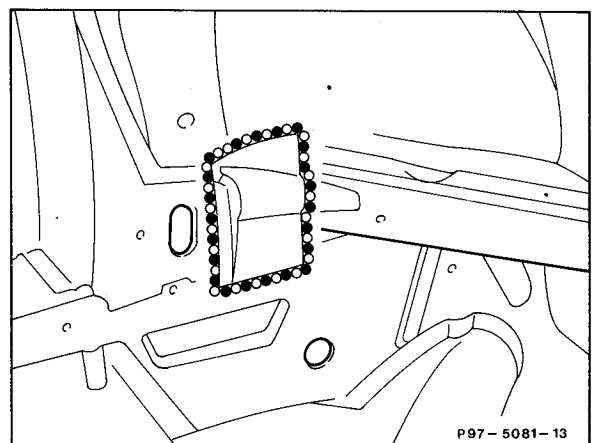

Reinforcement plate on inside on floor - front wall - tunnel on left and right.

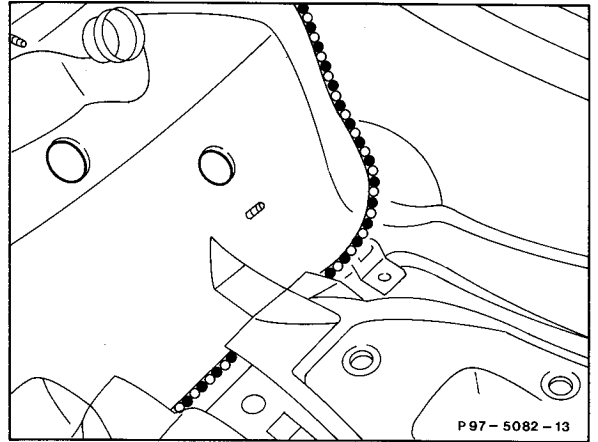

B-pillar wheelhouse - rear area, inside left.

B-pillar at top (arrow), seal seam from inside.

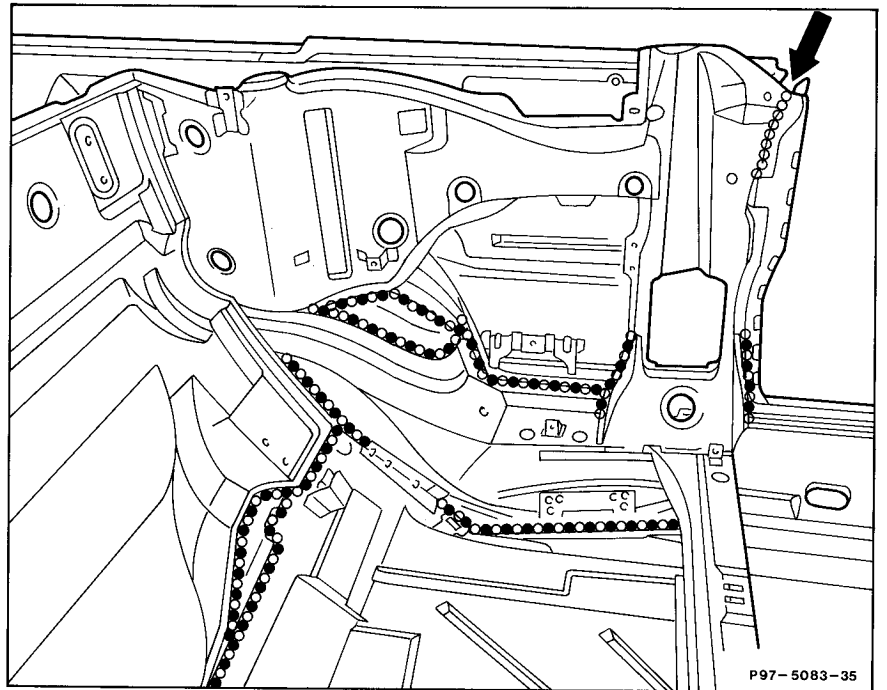

B-pillar wheelhouse - rear area, inside right.

B-pillar at top (arrow), seal seam from inside.

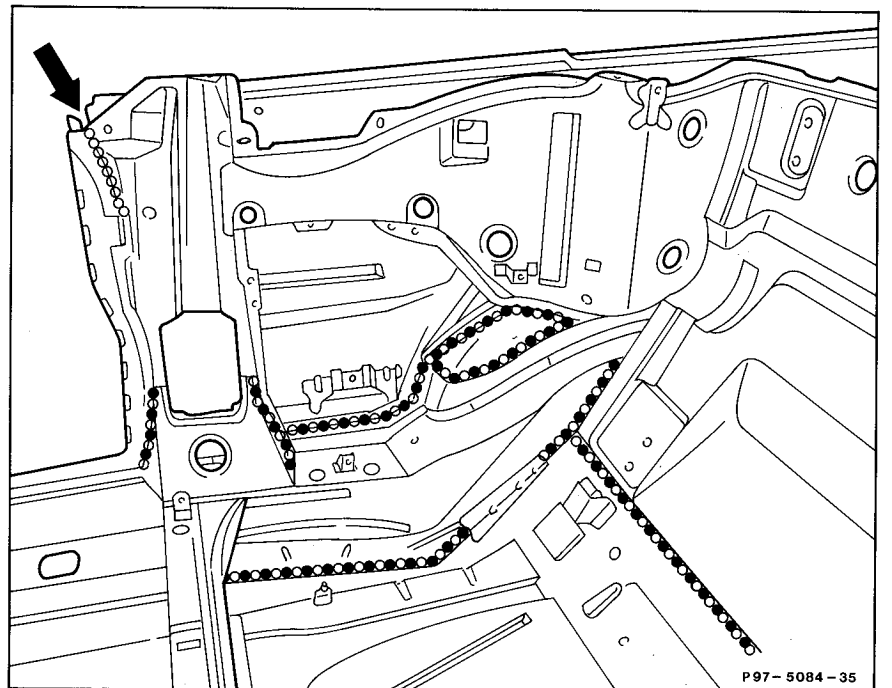

Soft top main mount - side wall, left and right.

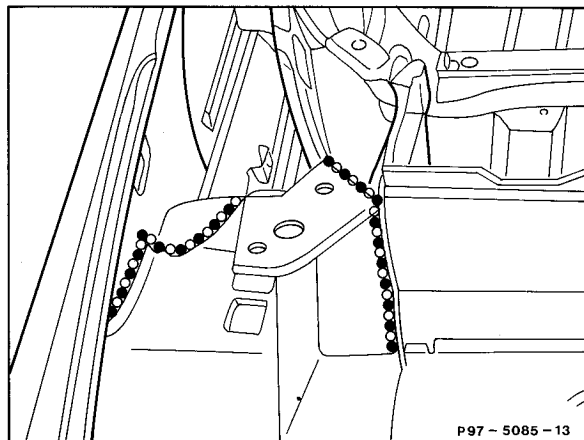

Left trunk recess.

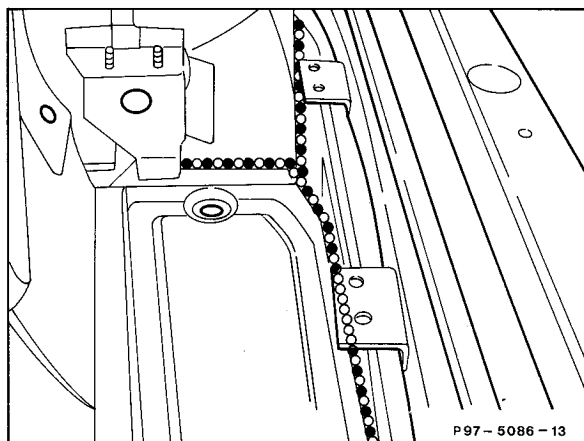

Right trunk recess.

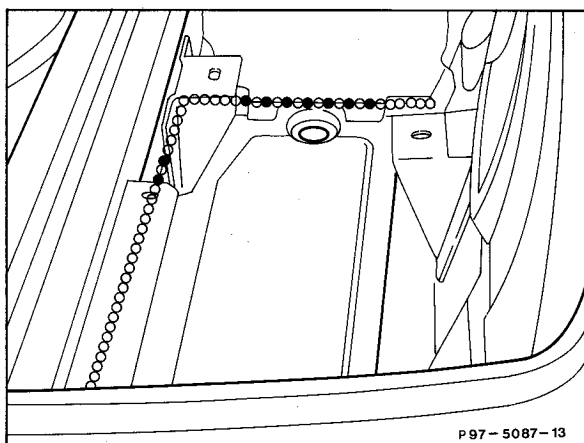

Wheelhouse, inside right, spare wheel recess  
inside right.

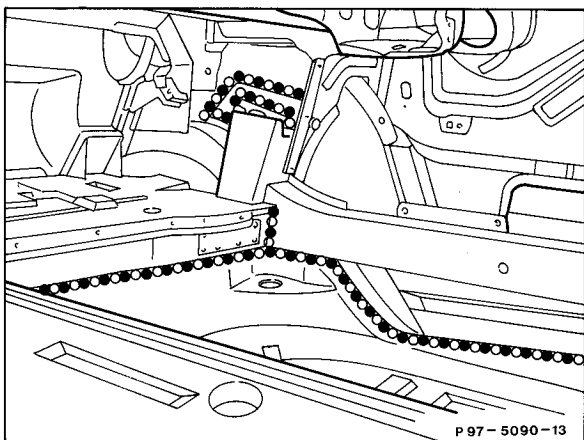

400 327

Wheelhouse, inside left, trunk floor. Spare wheel recess inside left.

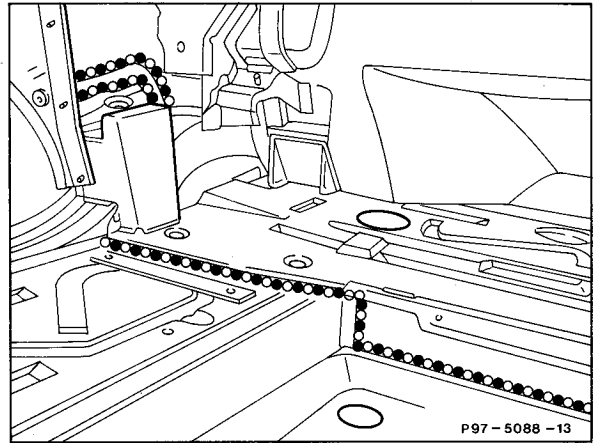

Rear console on floor assembly for diagonal struts.

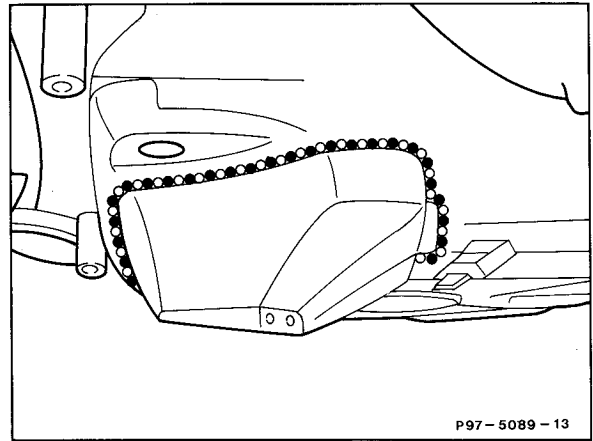

Connecting seam between roof frame and A-pillar on left and right.

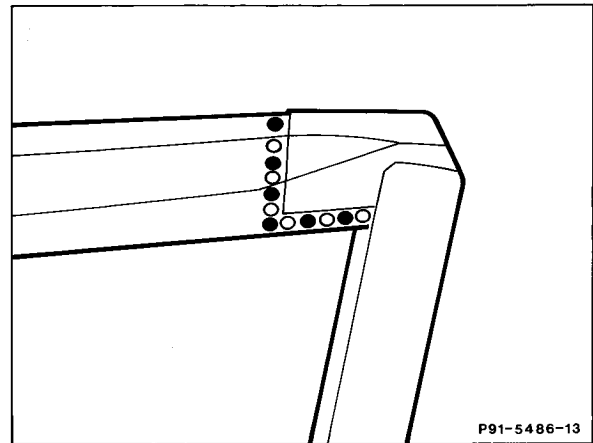

11.07.2011 - 400.000