

15-705 Function of preglow system - Turbodiesel

General

Combustion in the diesel engine occurs through the injection of self-igniting diesel fuel into highly compressed and therefore, hot combustion air.

When the engine is cold, the self-ignition temperature is not reached by compression alone. A preglow system is therefore required to increase the temperature of the compressed air and to allow the engine to start by directly igniting fuel particles on the glow plugs.

The duration of preglow depends on the ambient temperature.

Design of the quick-start pencil-type glow plugs

The pencil-type glow plugs consist essentially of a housing with an M12 x 1.25 internal thread and a heating element press-fitted into the housing.

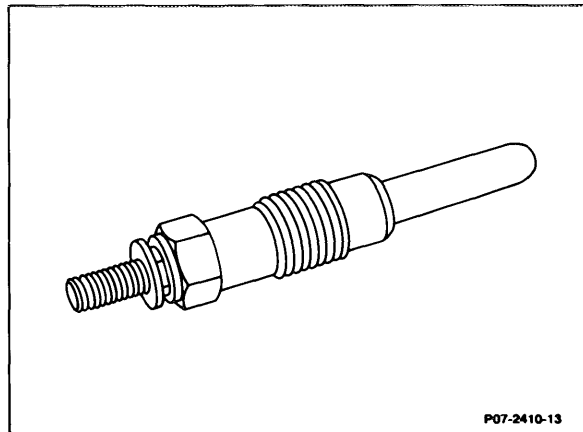

The single-pole connecting pin is screwed into the housing by a non-detachable brass round nut.

The pencil-type glow plugs are designed for a voltage of 11.5 Volts and are connected in parallel.

The heating element consists of a series-connected heating and control coil.

- 1 Control winding
- 2 Heating winding

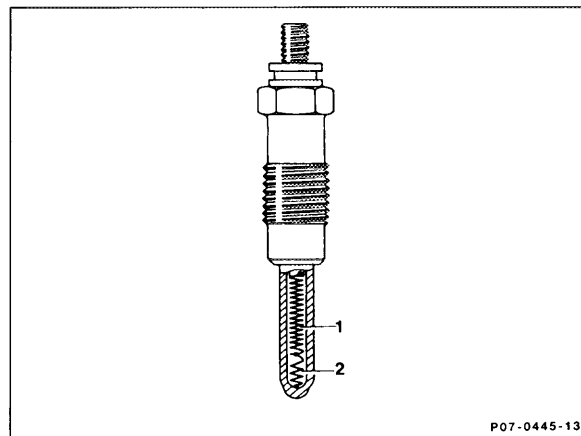

P07-0445-13

When the glow system is turned on, a current of approx. 30 A is supplied to each glow plug. The heater coil heats the glow plug very rapidly. The control coil resistance increases with rising temperature, limiting the current to approximately 8-15 A. The glow plug is thus protected against overload.

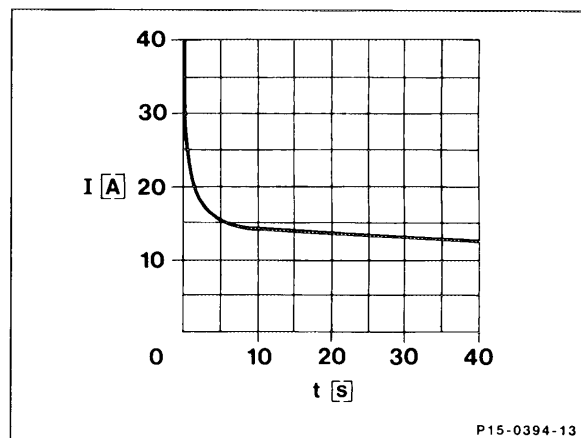

P15-0394-13

Current curve of quick-start pencil-type glow plug

After a glow period of 9 seconds, a heating element temperature of 900°C is reached, the maximum temperature of 1180°C being reached after 30 seconds.

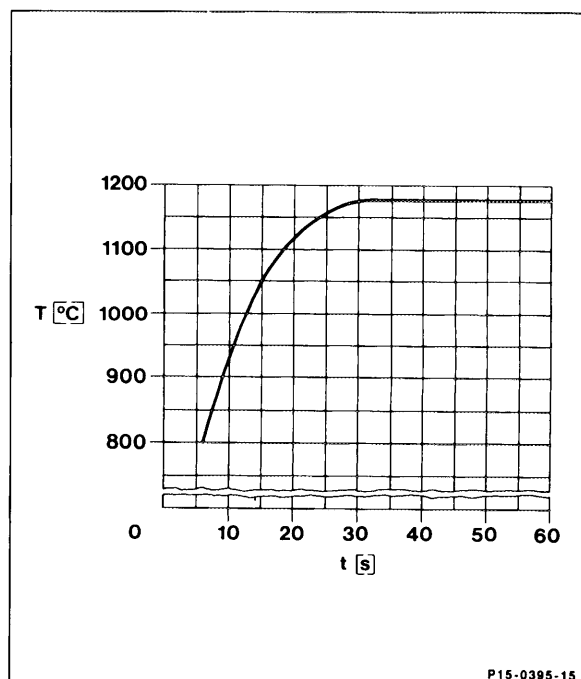

P15-0395-15

Temperature curve of quick-start pencil-type glow plug

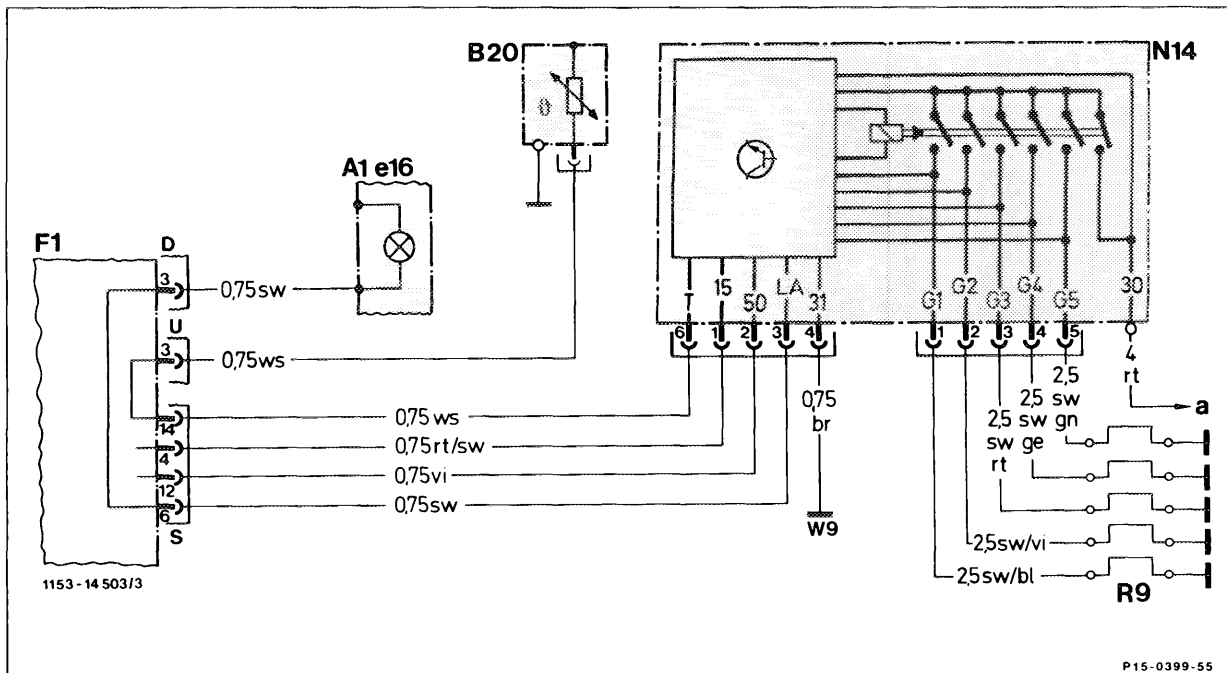

Wiring Diagram Engine 602.961, Model 201.128

- A1e16 Instrument cluster, preglow indicator
- B20 Temperature sensor (preglow)
- F1 Electrical centre
- N14 Preglow time relay

- R9 Glow plugs
- W9 Ground, front left (next to lamp unit)
- a X35 terminal block, terminal 30

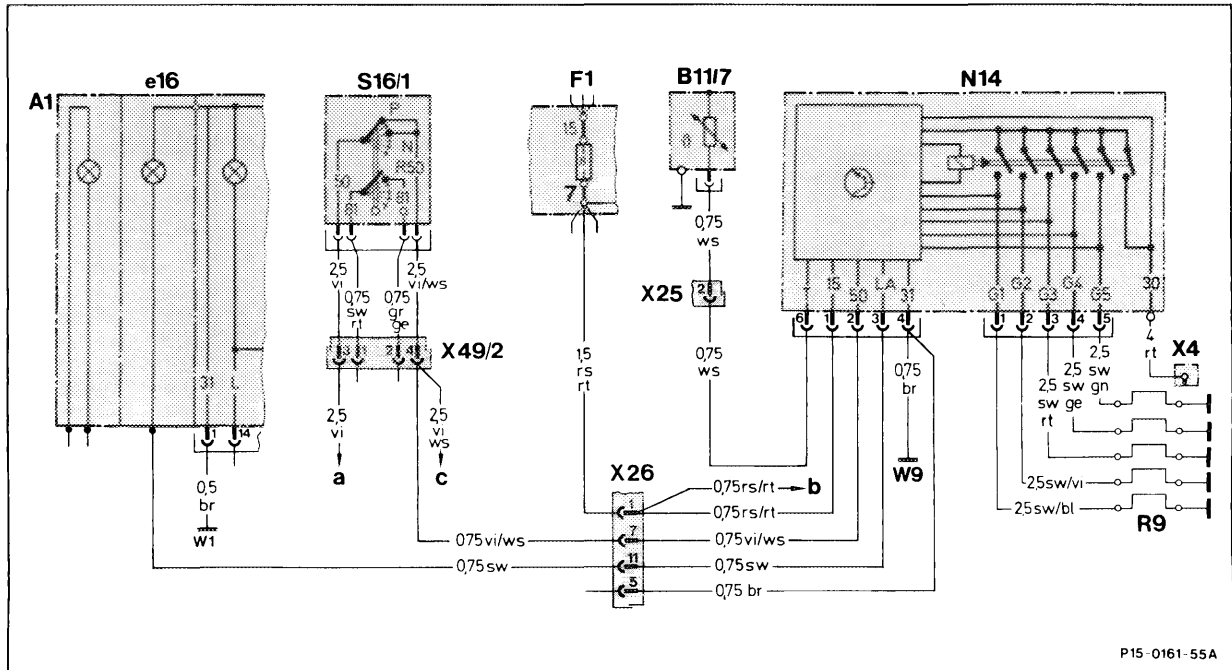

Wiring Diagram Engine 602.962, Model 124.128

A1e16	Instrument cluster, preglow indicator	X4	Terminal block, terminal 30 (fuse and relay box)
B11/7	Temperature sensor (preglow)	X25	Plug connector, preglow wiring harness
F1	Fuse and relay box	X26	Plug connector, interior/engine 12-pin
N14	Preglow time relay	X49/2	Plug connector, starter lockout and backup light switch
R9	Glow plugs	a	S2/2 glow start switch terminal 50
S16/1	Starter lockout and backup light switch (with automatic transmission only)	b	K1 Relay, over-voltage protection contact 3 (with air-conditioning system only)
W1	Main ground (behind instrument cluster)	c	X27 plug connector, starter wiring harness contact 2
W9	Ground, front left (next to lamp unit)		

Preglow time relay

The preglow time relay is housed in the engine compartment on the left wheel arch.
The electrical connections are accessible after removing the protective cap.

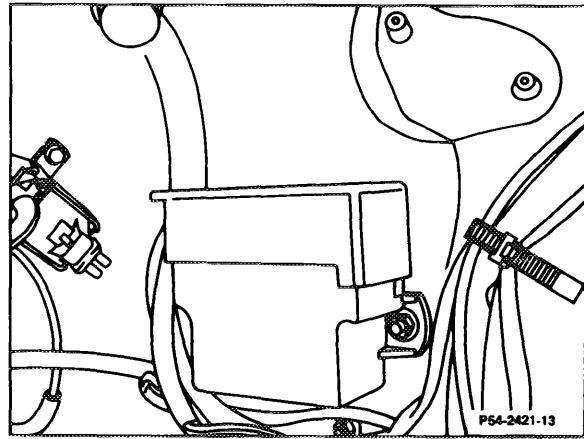

Installation of preglow time relay shown on Model 201

Functions of preglow time relay

The preglow time relay has the following functions:

- Activating the glow current
- Indicating readiness to start
- Safety cutout
- Identifying faults

Preglow without afterglow Model 124 engine 603.96

T Ambient temperature of preglow time relay in °C

t Preglow time in seconds

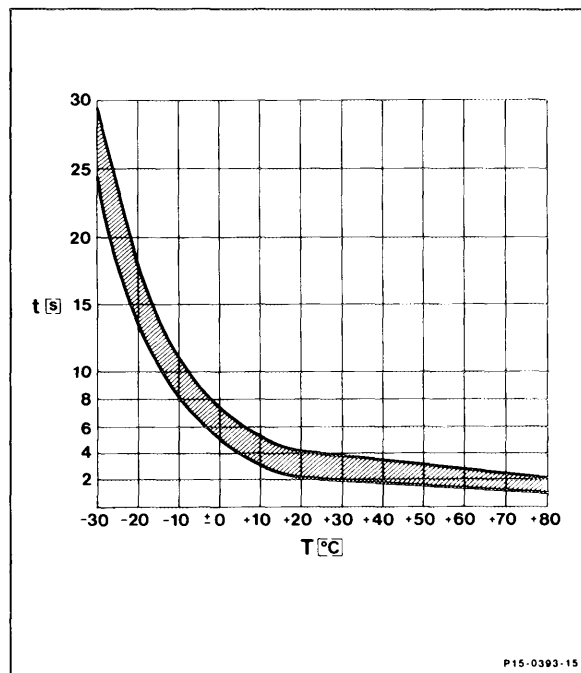

P15-0393-15

Preglow with afterglow

Preglow Time

T Coolant temperature in °C
 t Preglow time in seconds

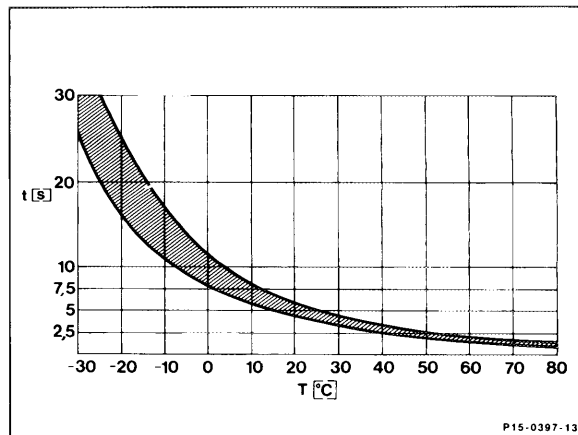

Afterglow Time

To improve warm-up properties, the glow plugs continue to glow when the engine is running dependent on the coolant temperature.

a) Version:
 Model 201 Engine 602.961 Model Year 1988

T Coolant temperature in °C
 t Afterglow time in seconds
 Afterglow time up to max. 175 s (refer to diagram)

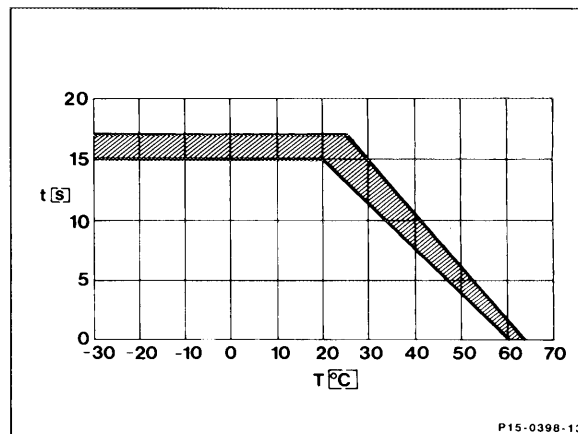

b) Version:
 Models 124, 201 Engine 602.961/962,
 Model 124 Engine 603.96 from Model Year 1989

T Coolant temperature in °C
 t Afterglow time in seconds
 Afterglow time up to max. 60 s (refer to diagram)

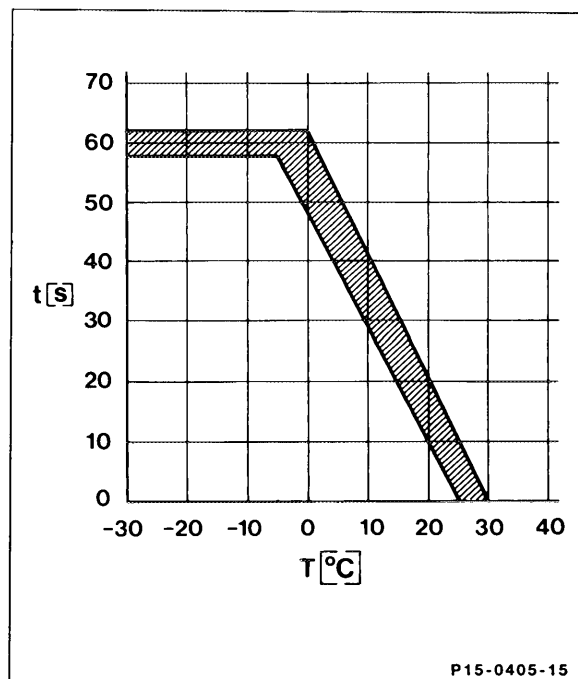

Safety cutout

If the engine is not started within 20-25 seconds after the readiness to start indication being given, the glow current is interrupted by the safety cutout. If the engine is then started, the glow system is switched on again for the duration of the starting operation.

The duration of safety cutout is not fixed. It is the combination of time up to readiness to start (preglow indicator lamp going out) plus 20-25 seconds.

b Safety cutout

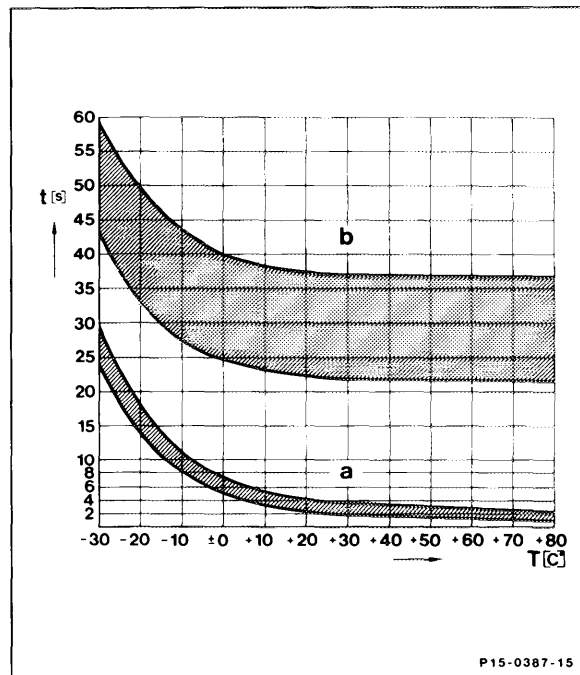

Switching the glow current

When the key is moved into position "2" (preglow, drive), the preglow time relay is switched on (voltage to terminal 15). The preglow time relay closes the circuit from terminal 30 (positive) to the glow plugs (R9).

If the key is turned into position "3" (start), the preglow time relay remains activated and remains retracted through terminal 50. The glow process is continued until the key is turned back to position "2".

Readiness to start indication

a) Model 124 Engine 603.96

When the glow system is switched on, the preglow indicator lamp in the instrument cluster lights up. The glow duration is determined by a temperature sensor installed in the preglow time relay. Once the required glow time has been reached, depending on the ambient temperature of the preglow time relay, the preglow indicator lamp goes out, thus indicating that the engine is ready to start.

**Model 201 Engine 602.961,
Model 124 Engine 602.962, Engine 603.96
effective 1989**

When the glow system is switched on, the preglow indicator lamp in the instrument cluster lights up. The glow duration is determined by the temperature sensor in the coolant. Once the required glow time has been reached, the preglow time relay switches off the preglow indicator lamp, indicating that the engine is ready to start.

Fault Indication

Model 124 Engine 603.96

A fault in the preglow system is indicated by the preglow indicator lamp failing to light up when the key is moved into position "2".

The following faults are detected:

- Interrupt in the cable to connection terminal 30.
- 80 ampere fuse faulty.
- Fault in power relay of preglow time relay.
- Interrupt in one or more cables to the glow plugs.
- Open circuit in one or more glow plugs.

Fault Indication

**Models 124, 201 Engine 602.961, 602.962,
603.96 Effective 1989**

A fault in the preglow system is indicated by the preglow indicator lamp failing to light up when the key is turned into position "2". In addition, the preglow indicator lights up for approx. 1 minute when the engine is running.

The following faults are detected:

- Interrupt in the cable to connection terminal 30.
- Preglow time relay faulty.
- Open circuit in one or more cables to the glow plugs.
- Open circuit in one or more glow plugs.
- Short-circuit at one or more glow plugs or in the cables.